

2026

PRODUCT CATALOG

**ADVERTISING MEDIA AND DISPLAY SYSTEMS
FOR PRINTING HOUSES AND ADVERTISING AGENCIES**



ABOUT US / ÜBER UNS / O NAS

 We are one of the largest manufacturer and distributor of advertising media and display systems in Europe. Our offer includes a.o.: roll-ups, ad. walls, flag poles, wooden products, tent frames and much more.

 Wir sind einer der größten Hersteller und Vertrieber von Werbesystemen in Europa. Unsere Produktpalette umfasst Roll-Ups, Fahnenmasten, Holzprodukte, Zeltgestelle und vieles mehr.

 Jesteśmy jednym z największych producentów i dystrybutorów systemów reklamowych w Europie. W naszej ofercie znajdziesz m.in. roll upy, maszty flagowe, produkty drewniane, potykacze, stelaże namiotów i wiele więcej.



OFFICE
POZNAŃ
POLAND



WAREHOUSE
RZESZÓW
POLAND

WE GUARANTEE / WIR GARANTIEREN IHNEN / GWARANTUJEMY:



CUSTOMIZED PRICE OFFER



24/7 ONLINE ACCESS TO OUR WAREHOUSE



FAST DELIVERY TO ALL EU COUNTRIES



TECHNICAL SUPPORT RESULTING FROM 20 YEARS OF EXPERIENCE

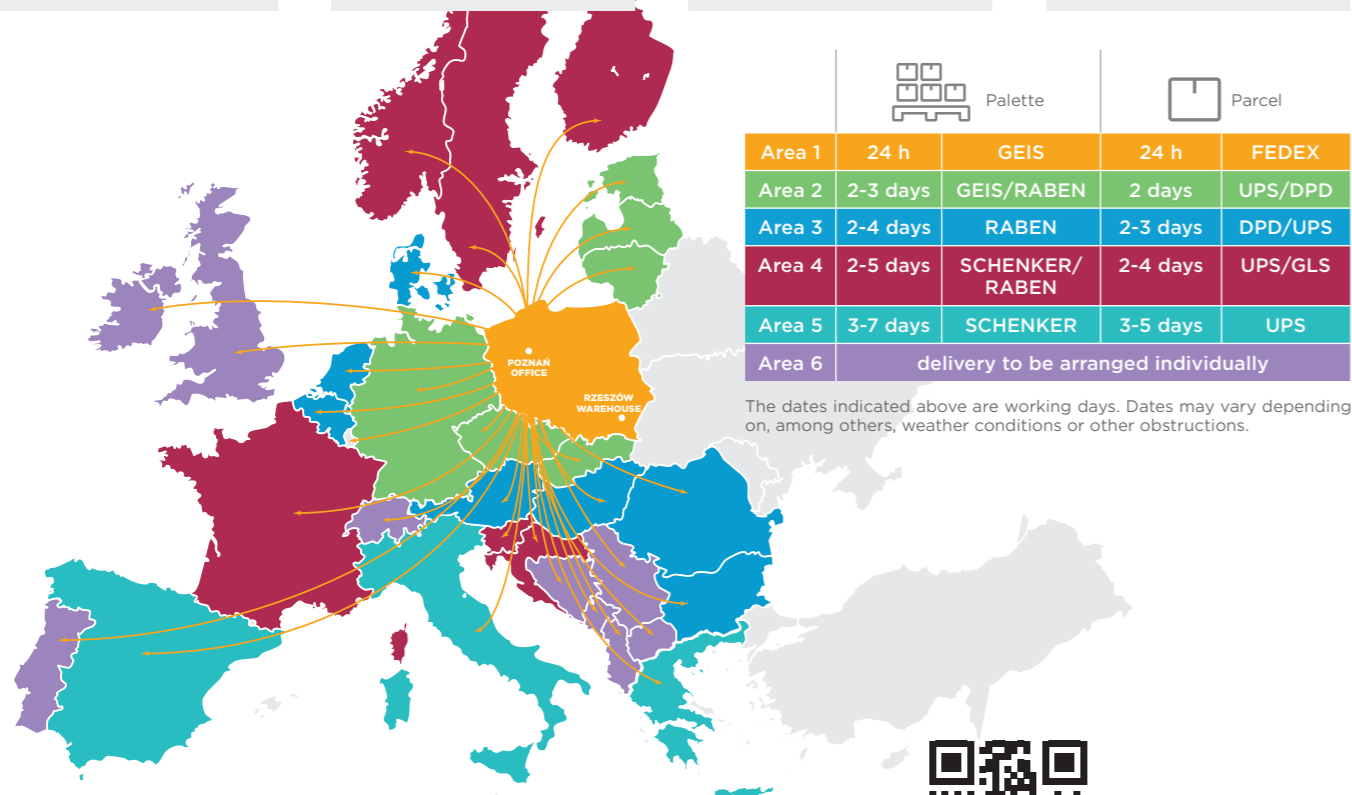

**JOIN US ON
SCHLIESSEN SIE SICH UNS AN
DOŁĄCZ DO NAS**

WWW.PROMEDIAPLUS.PL

TABLE OF CONTENTS

INDOOR

LED It's time to shine!	5	STANDS	63	Atlanta	102
LED BOX™ Compact	6	X-Banner Compact	64	Columbia	103
LED BOX™ 2.0	7	X-Banner Standard	64	Lincoln	103
LED BOX™ Flex	8	L-Banner	65	Counter Dallas	104
LED BOX™ Plus 2.0	10	Atlantis Expo	66	Counter Concord	104
LED BOX™ Wall Frame	12			Virginia	104
LUNIX™ RGB Wall	13	ADVERTISING WALLS	67		
LUNIX™ System	14	Mega Seg™ System	68	POSTER FRAMES & RAILS	105
LUNIX™ Silver	15	Pop-Up Straight	70	Poster Rails	106
LUNIX™ Black	15	Pop-Up Arc	71	Standard	107
Backlight Wall	18	Standard Magnetic Pop-Up Straight	72	Slim	107
LED BOX™ Counter	20	Standard Magnetic Pop-Up Arc	73	Clip	107
LED BOX™ Counter With Shelf	21	Premium Magnetic Pop-Up Straight	74	Twin	107
LUNIX™ Counter	22	Premium Magnetic Pop-Up Arc	75	Vertico Hanging Frames	108
Preston Automatic Led Counter	23	Black Pro Magnetic Pop-Up Straight	76	Snap Frames Standard	109
Preston Automatic Oval Led	23	Black Pro Magnetic Pop-Up Arc	77	Snap Frames Silver	109
Preston Automatic Rectangle Led	23	Velcro Pop-Up Straight	78	Snap Frames Black	109
Backlight Counter	24	Velcro Pop-Up Arc	79	Snap Frames Premium	110
Fabrics For Printing On Led Systems	24	Atlantis Straight	80	Magnetic Frames	111
		Atlantis Arc	81	Magnetic	111
TRADE FAIRS	25	Atlantis S-Shape	82	Magnetic Reworkers	111
LUNIX™ Exhibition Booths	26	Atlantis U-Shape	83	Magnetic Safety	111
LUNIX™ Exhibition Booths Accessories	28	Combi Systems	84	Door Signs	112
Saver Case	29	Versum	85	Sonic	112
Transport Cases	30	Advertising Wall Accessories	86	Gert	112
				Elite	113
ROLL UP	31	COUNTERS & BROCHURE HOLDERS	87	Puro	113
Roll Ups Comparison	32	Promo Counters	88	Manta	113
Compact	34	Promo 2 Plus Counters	90	Acrylic Stands	114
Standard	36	Topper Counter	90	Crystal	114
Standard Black	38	Pop-Up Velcro Counter	91	Platinum	114
Standard Plus	40	Preston Counters	92	Vista	114
Classic	42	Preston Automatic Counters	94	Rod Systems	116
Basic	44	Pop-Up Counters	95	Wall To Wall System	116
Premium	46	LUNIX™ Counter	96	Wall To Floor/Ceiling System	116
Pro	48	LED BOX™ Counter	97	Ceiling To Floor System	117
Exclusive	50	LED BOX™ Counter with shelf	98	Ceiling To Board System	117
Exclusive Black	52	Backlight Counter	99	Accessories	118
Exclusive Plus	54	Brochure holders	100		
Wave	56	Montana Silver	100		
Clip	58	Montana Black	101		
Twin	60	Boston	102		
Roll Up Accessories	62				

OUTDOOR

PAVEMENT SIGNS	118	LOUNGERS	135	Pole Base	148
Aurora	120	Wooden Lounger	136	Rotators	152
Spider	121	Aluminium Lounger	136		
Hampton	122			TENT FRAMES	153
Hampton Pro	123	QUEUE BARRIER	137	Tent Frames	154
Seg	124	Premium Barrier	138	Tent Canopy	156
Info Stand Chroma	124	Replacement Heads	138	Accessories	156
Info/Menu Stand Puladi	125	Hotel Barrier	139		
Info/Menu Stand Classic	126	Royal Chrome	139	EVENT FURNITURES	157
Info/Menu Stand Standard	126	Modern Chrome	139	Tables	158
Info/Menu Stand Premium	127	Royal Gold	139	Cocktail Table 80	158
Metal Easel	128	Modern Gold	139	Event Table 180x75	158
		Velvet Border	139	Event Table Round 122	158
WOODEN PRODUCTS	129	Laced Border	139	Table Header	159
Chalkboard Signs Classic	130	Barrier Post Info Frame	140	Tablecloth	159
Classic	130	Wall Mounted Head	140	Tablecloth 80	159
Classic Natural	130			Tablecloth 122	159
Classic Red	131	FLAG POLES	141	Tablecloth 180	159
Classic Black	131	Standard Pole	142	Chairs	160
Classic Green	131	Standard Plus Pole	143	Folding Chair	160
Chalkboard Sign Pro Waterproof	132	Pro Pole	144	Cocktail Chair	160
Liquid Chalk Markers	132	H Poles	145	Cocktail Chair Cover	160
Chalkboard	133	Avenue	145		
Table Stands	133	Tube Feather Flagpole	146		
Easel	133	Tube H Flagpole	147		

The product dimensions and weights shown in the catalogue are indicative. They may vary slightly depending on the delivery batch. • Die im Katalog angegebenen Produktabmessungen und Gewichte sind Richtwerte. Sie können je nach Lieferlos leicht variieren. • Podane w katalogu wymiary i wagi produktów mają charakter orientacyjny. Mogą się nieznacznie różnić w zależności od partii dostawy.

NEW TOP HITS

SEG PAVEMENT SIGN

Sidewalk sign with a durable aluminium construction. A special lock prevents the product from being accidentally folded. A practical handle allows it to be easily transported. Mounting the fabric printout takes a few seconds.

More info - page 122



SILICONE TAPE MOUNTED PRINTOUT



NO TOOLS



DOUBLE SIDED

BACKLIGHT WALL

Illuminated advertising wall with LED curtain. Aluminium light strips with a huge number of bulbs evenly illuminate the entire printout. The back of the curtain does not let light through, which allows the graphics to be highlighted even better.

More info - page 18-19



UP TO 960 LED BULBS



SILICONE TAPE MOUNTED PRINTOUT



NO TOOLS



WHEELED BAG

LUNIX™ RGB WALL

A unique LED system with a built-in lighting colour change mechanism. A wide aluminium profile (12 cm) ensures high quality and stability of the entire system. RGB walls can be connected to the LUNIX™ system, to create unique structures.

More info - page 13

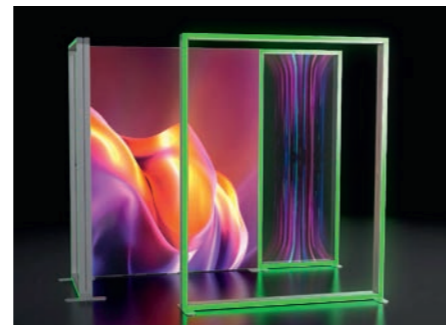

WIDE ALUMINIUM PROFILE



NO TOOLS



SILICONE TAPE MOUNTED PRINTOUT



WHEELED BAG



DOUBLE SIDED

Lighting colours:



It's time to shine!

LED

LED BOX™ COMPACT

NEW!

- double-sided LED system
- aluminium frame (6,5 cm)
- **design based on quick-connects for powering the integrated LED lighting**

The set includes: LED BOX Compact, power adapter, silicon tape, cardboard case.

- leichtes, beleuchtetes, doppelseitiges System
- Rahmenbreite - 6,5 cm
- **Konstruktion mit Schnellverbindern für die integrierte LED-Beleuchtung**

Das Set enthält: LED BOX COMPACT, Netzteil, Silikonband, Transportkoffer aus Karton.

- dwustronny, podświetlany system LED
- profil aluminiowy (6,5 cm)
- **konstrukcja bazująca na szybkozłączkach zasilających oświetlenie LED**

Zestaw zawiera: LED BOX COMPACT, zasilacz, taśmę silikonową, walizkę kartonową.



LED BOX™ 2.0

NEW!

- double-sided LED system
- durable aluminium frame (8,5 cm)
- **design based on quick-connects for powering the integrated LED lighting**
- **the LED bulbs do not exceed the profile**
- available in cardboard case or wheeled bag

The set includes: LED BOX 2.0, power adapter, silicon tape, cardboard case/transport bag.

- leichtes, beleuchtetes, doppelseitiges System
- Rahmenbreite - 8,5 cm
- **Konstruktion mit Schnellverbindern für die integrierte LED-Beleuchtung**
- **keine herausragenden LED-Leuchten**
- erhältlich in Transportkoffer aus Karton oder Rolltasche

Das Set enthält: LED BOX 2.0, Netzteil, Silikonband, Transportkoffer aus Karton/Transporttasche.

- dwustronny system ze zintegrowanym oświetleniem LED
- profil aluminiowy - 8,5 cm
- **konstrukcja bazująca na szybkozłączkach zasilających oświetlenie LED**
- **żarówki LED nie wystają poza profil**
- dostępny w walizce kartonowej lub torbie na kółkach

Zestaw zawiera: LED BOX 2.0, zasilacz, taśmę silikonową, walizkę z kartonu/torbę transportową.



LED BOX 2.0 PRODUCTS CAN BE CONNECTED TO EACH OTHER USING PARALLEL OR CORNER CONNECTORS.

85x200	5904423600791	5,5 kg
100x200	5904423600807	5,7 kg

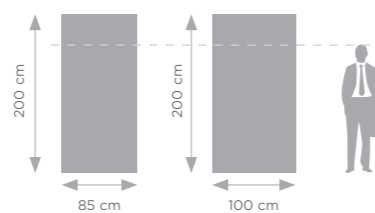

Recommended media and printing technology for this system:

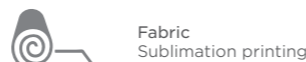

100x200 (silver)	5907451664001	7 kg
100x200 (silver / bag)	5907451666906	7 kg
100x230 (silver)	5907451669921	9 kg
100x230 (silver / bag)	5907451666913	9 kg
100x250 (silver)	5907451669914	12 kg
100x250 (silver / bag)	5907451666920	12 kg
100x200 (black)	5907451667507	7 kg
100x230 (black)	5907451667514	9 kg
100x250 (black)	5907451667521	12 kg

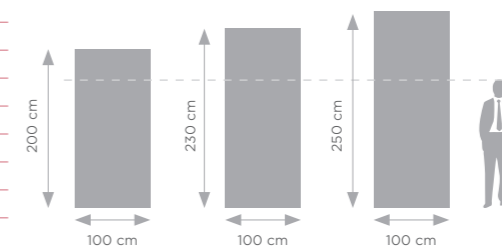

Recommended media and printing technology for this system:



LED BOX™ FLEX

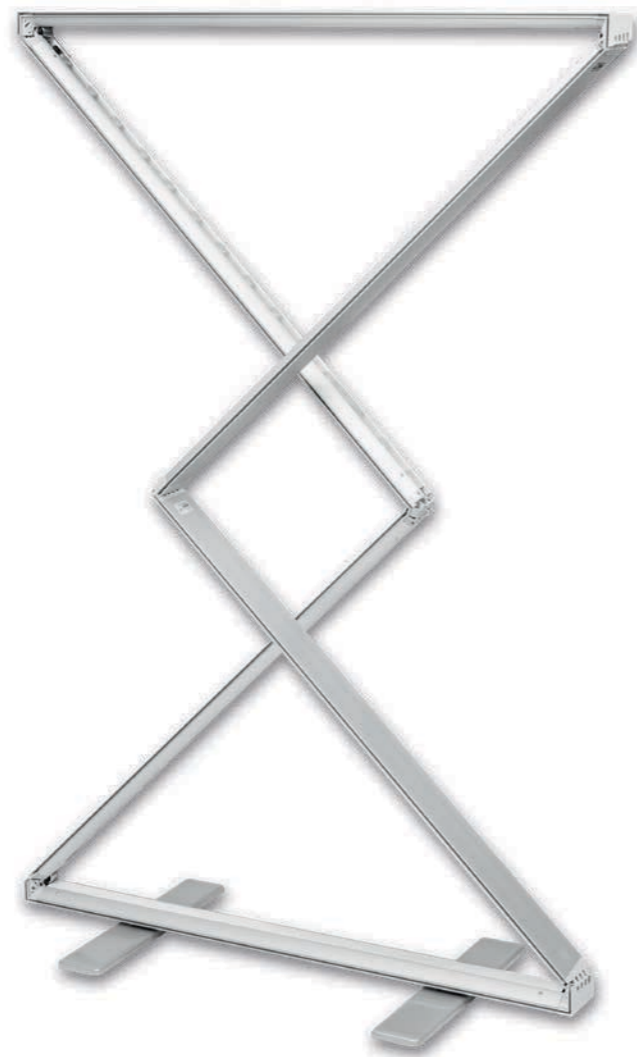

- flex system - faster and easier assembly thanks to its hinge-based construction
- durable aluminium frame (8,5 cm)
- Integrated LED lighting powered by quick-connectors (power cables hidden in the aluminium profiles)
- silicon tape mounted printout
- no tools assembly

The set includes: LED BOX FLEX, power adapter, transport bag.

- sistema flex - montaje más rápido y sencillo gracias a su estructura con bisagras
- perfil de aluminio (8,5 cm)
- construcción basada en conectores rápidos que suministran iluminación LED
- montaje sin herramientas
- impresión montada con cinta de silicona

El juego incluye: LED BOX FLEX, fuente de alimentación, bolsa de transporte.

- système flex - assemblage plus rapide et plus facile grâce à sa construction à charnières
- profilé aluminium (8,5 cm)
- l'éclairage LED intégré, alimenté par des connecteurs rapides (câbles d'alimentation dissimulés dans les profilés en aluminium)
- montage sans outils
- impression montée sur ruban en silicone

Le kit comprend: LED BOX FLEX, une alimentation, un sac de transport.



LED BOX FLEX IS DISTINGUISHED BY ITS HINGE-BASED CONSTRUCTION, WHICH SIMPLY NEEDS TO BE OPENED.

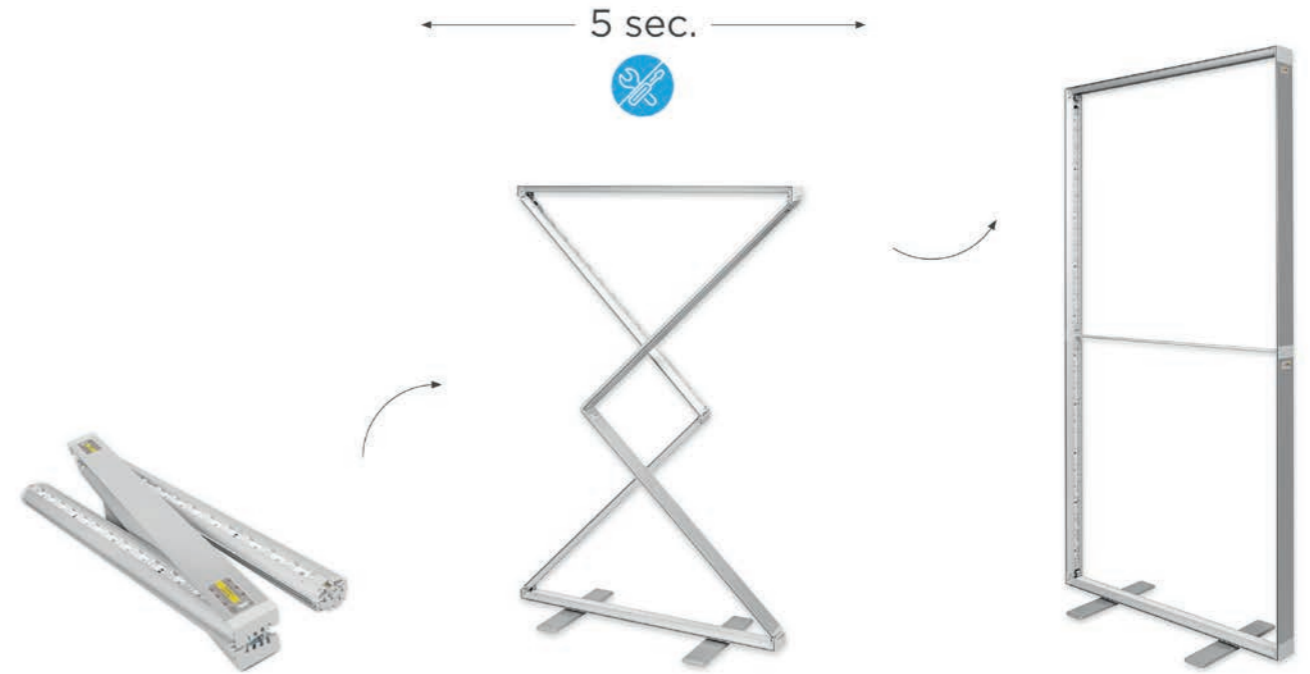

THANKS TO EMBEDDED MAGNETS, THE LED BOX FLEX PRODUCTS CAN BE CONNECTED IN SERIES TO EACH OTHER FOR CREATING SYSTEMS OF DIFFERENT SIZE.

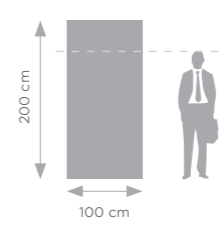
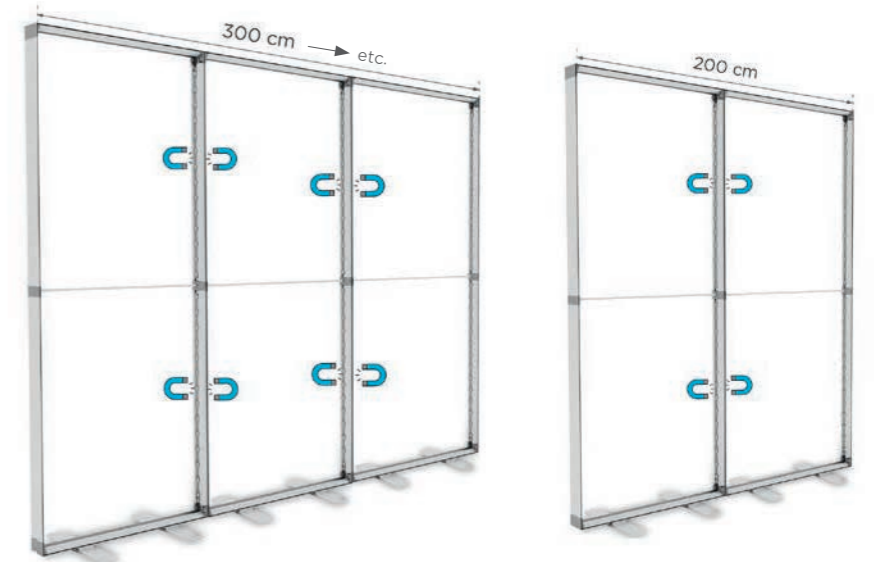

100x200	5907451667415	7 kg
---------	---------------	------

Recommended media and printing technology for this system:

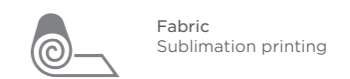

LED BOX™ PLUS 2.0

NEW!



- double-sided LED system
- **wide aluminium profile (10 cm)**
- **flex system - faster and easier assembly thanks to its hinge-based construction**
- wheeled transport bag

The set includes: LED BOX PLUS 2.0 wall, power adapter, silicon tape, transport bag.

- doppelseitiges System
- **breiter Aluminiumrahmen (10 cm)**
- **Flex-System - schnellere und einfachere Montage dank einer auf Scharnieren basierenden Konstruktion**
- Premium-Tasche auf Rollen

Das Set enthält: LED BOX PLUS 2.0 Messewand, Netzteil, Silikonband, Transporttasche.

- dwustronna ścianka LED
- szeroki profil aluminiowy (10 cm)
- system „flex” - szybszy i łatwiejszy montaż dzięki konstrukcji opartej na zawiasach
- torba Premium na kółkach

Zestaw zawiera: ściankę LED BOX PLUS 2.0, taśmę silikonową, zasilacz, torbę transportową.



LED BOX PLUS 2.0 IS DISTINGUISHED BY ITS HINGE-BASED CONSTRUCTION, WHICH SIMPLY NEEDS TO BE OPENED.

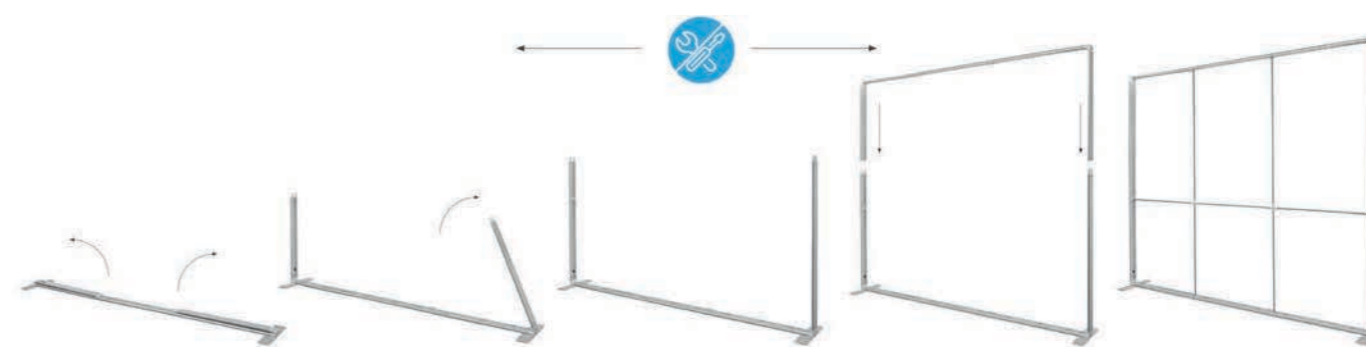

LED BOX PLUS 2.0 PRODUCTS CAN BE CONNECTED TO EACH OTHER USING PARALLEL OR CORNER CONNECTORS.

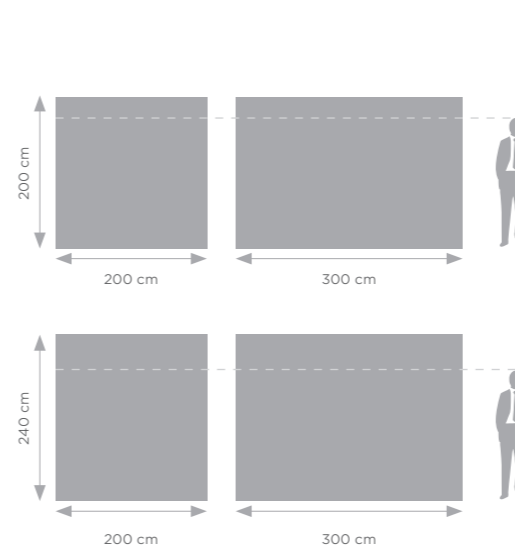

200x200	5907451668870	15 kg
300x200	5907451668856	22 kg
200x240	5907451668863	16 kg
300x240	5907451668849	23 kg



Recommended media and printing technology for this system:



Fabric Sublimation printing

LED BOX™ WALL FRAME

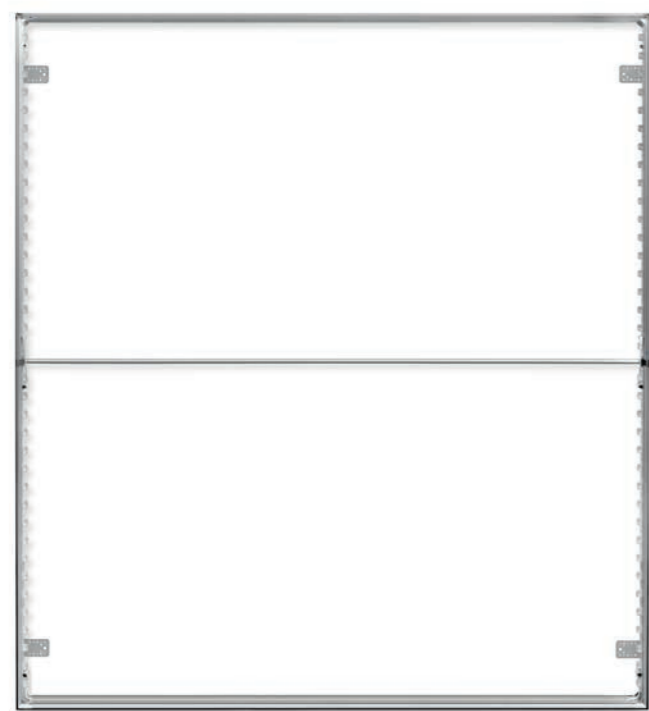

- suspended LED system
- aluminium frame - 8 cm
- no tools assembly
- silicon tape mounted printout

The set includes: LED BOX™ WALL FRAME, mounting accessories, power cable.

- abgehängtes System
- Rahmenbreite - 8 cm
- Druck auf Stoff, montiert auf Silikonband
- werkzeuglose Montage

Das Set enthält: LED BOX™ Wandrahmen, Montagezubehör, Netzkabel.

- podwieszany system LED
- profil aluminiowy - 8 cm
- montaż bez narzędzi
- wydruk montowany za pomocą taśmy silikonowej

Zestaw zawiera: LED BOX™ WALL FRAME, akcesoria montażowe, przewód zasilający.

91,5x91,5	5907451668481	2,3 kg
100x150	5907451666425	4,5 kg

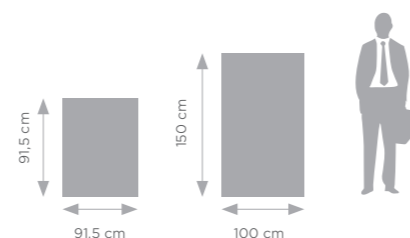

Recommended media and printing technology for this system:

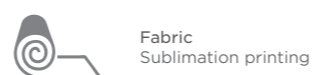

LUNIX™ RGB WALL



NEW!

- double-sided LED system
- built-in light colour change mechanism (6 colours in 1 system)
- wide aluminium profile (12 cm)
- silicon tape mounted printout
- wheeled transport bag

The set includes: LUNIX™ RGB WALL, power adapter, transport bag.

- doppelseitiges LED-System
- integrierter Mechanismus zur Änderung der Lichtfarbe (6 Farben in einem System)
- breiter Aluminiumrahmen (12 cm)
- Druck auf Stoff, montiert auf Silikonband
- Transporttasche mit Rollen

Das Set enthält: LUNIX™ RGB-Wand, Netzteil, Transporttasche.

- dwustronny system LED
- wbudowany mechanizm zmiany koloru oświetlenia (6 kolorów w 1 systemie)
- szeroki profil aluminiowy (12 cm)
- wydruk montowany za pomocą taśmy silikonowej
- solidna torba na kółkach

Zestaw zawiera: ściankę LUNIX™ RGB, zasilacz, torbę transportową.

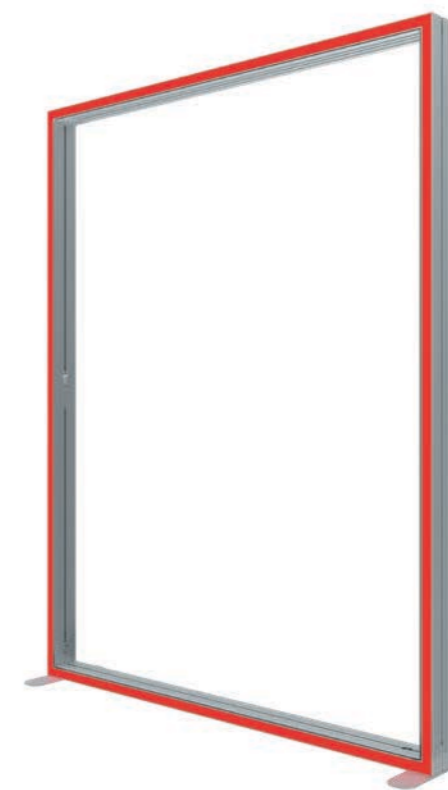

WIDE ALUMINIUM PROFILE



NO TOOLS



SILICONE TAPE MOUNTED PRINTOUT



WHEELED BAG



DOUBLE SIDED

RGB WALLS CAN BE CONNECTED TO EACH OTHER. THEY CAN ALSO BE CONNECTED TO THE LUNIX™ SYSTEM. TO COMBINE SYSTEMS USE LUNIX™ CONNECTORS (E.G.: T, X, TRIANGLE, 45° /60° /90° OR TOP CONNECTOR).

Lighting colours:

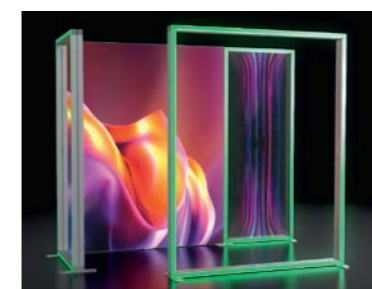
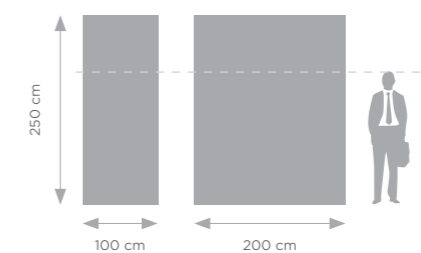
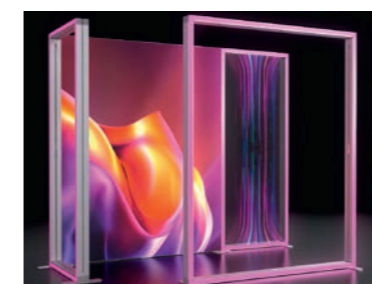

100x250	5907451669839	19 kg
200x250	5907451664797	24,2 kg

Recommended media and printing technology for this system:



LUNIX™ SYSTEM

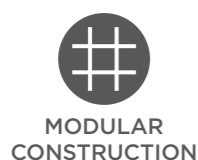

- double-sided LED system
 - modular construction - possibility to expand the systems
 - wide aluminium profile (12 cm)
 - no tools assembly
 - silicon tape mounted printout
 - sturdy Premium wheeled bag
- The set includes: LUNIX™ system, power adapter, transport bag.

- doppelseitiges LED-System
 - modulare Konstruktion - Möglichkeit der Erweiterung der System
 - stabiler Aluminiumrahmen (12 cm)
 - werkzeuglose Montage
 - Druck auf Stoff, montiert auf Silikonband
 - Premium Rolltasche
- Das Set enthält: LUNIX™ System, Netzteil, Transporttasche.

- dwustronny system LED
 - konstrukcja modułowa - możliwość rozbudowy systemów
 - szeroki profil aluminiowy (12 cm)
 - montaż bez narzędzi
 - wydruk montowany za pomocą taśmy silikonowej
 - solidna torba Premium na kółkach
- Zestaw zawiera: system LUNIX™, zasilacz, torbę transportową.

LUNIX™ SILVER



LUNIX™ BLACK



LUNIX™ SYSTEM
quality recognized
by TÜV!

TÜV-certified - International certification
of quality and safety



Safety
Regular
Production
Surveillance



www.tuv.com
ID 000088556

THE LUNIX™ IS ONE OF THE MOST IMPRESSIVE TRADE FAIR SYSTEM!

Wide range of accessories allows to connect the LUNIX™ systems to each other for creating unique exhibition stands.



CHECK OUR READY-MADE EXHIBITION BOOTHS - PAGES 26-28

THE LUNIX™ SYSTEMS CAN BE EXPANDED THANKS TO THE MODULAR CONSTRUCTION.

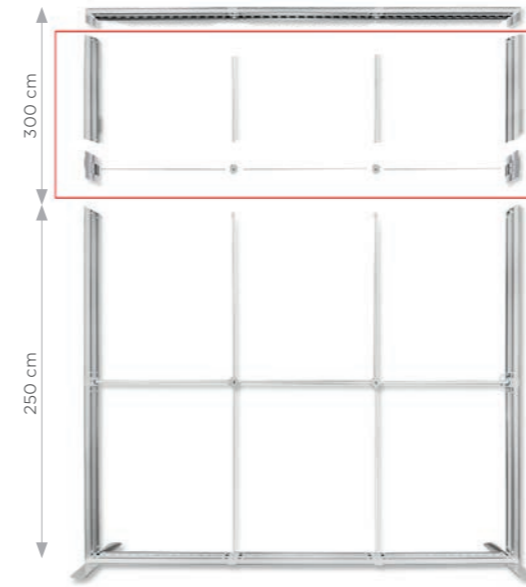

The Long Set allows to heighten the LUNIX™ by 50 cm - up to 300 cm.

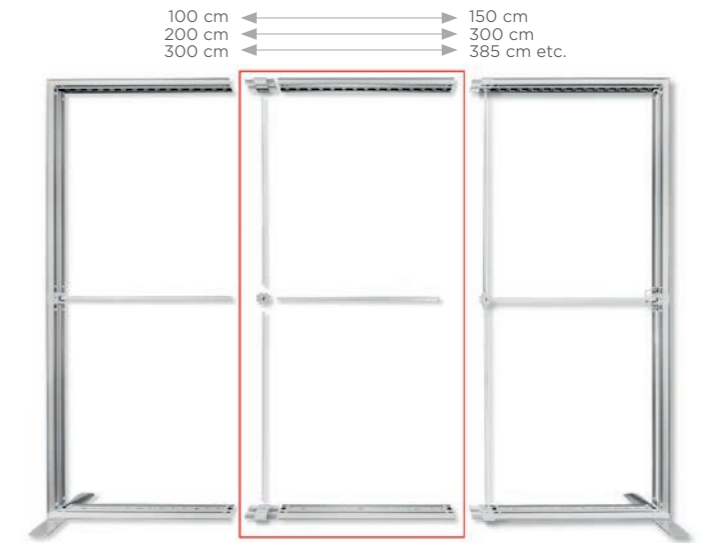

The XL Set enables to increase the LUNIX™ system width by 50, 85 or 100 cm.

Exhibition booth accessories make the LUNIX™ system even more functional.



A special monitor holder ensures additional multimedia presentation.



A practical shelves system enables additional display of products or advertising materials.



A illuminated storage room is a great solution to store materials needed during trade fairs.



A practical, illuminated roof allows to create even more eye-catching exhibition booth.

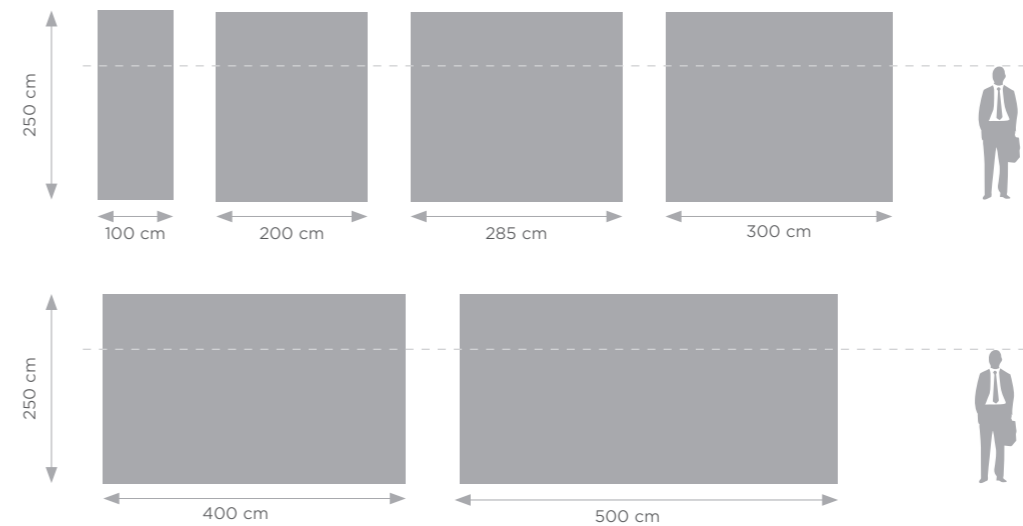

100x250 (silver)	5907451667361	12 kg
200x250 (silver)	5907451667002	21 kg
285x250 (silver)	5907451667187	26 kg
300x250 (silver)	5907451667019	27 kg
400x250 (silver)	5907451667026	29 kg
500x250 (silver)	5907451667033	36 kg
200x250 (black)	5907451669976	21 kg
285x250 (black)	5907451669426	26 kg
300x250 (black)	5907451669419	27 kg
400x250 (black)	5907451669846	29 kg
500x250 (black)	5907451669792	36 kg

Recommended media and printing technology for this system:



Fabric
Sublimation printing

BACKLIGHT WALL



NEW!



UP TO 960 LED BULBS

6,5 cm

ALUMINIUM PROFILE



SILICONE TAPE MOUNTED PRINTOUT



NO TOOLS



WHEELED BAG



BACKLIGHT WALLS CAN BE CONNECTED TO EACH OTHER USING PARALLEL OR CORNER CONNECTORS.

200x250	5907451662618	25 kg
300x250	5907451662663	29 kg
400x250	59078451668566	39 kg
500x250	5907451668580	48 kg
600x250	5904423600036	52 kg

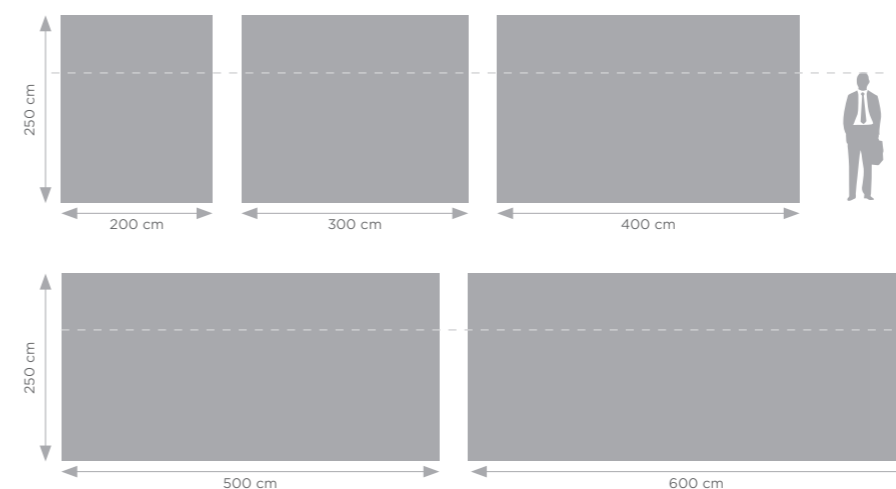

- LED curtain enables the entire printout to be evenly illuminated
- the back of the curtain is opaque, which allows for even better highlighting of the graphics
- aluminium light strips
- aluminium profile - 6,5 cm
- wheeled bag

The set includes: BACKLIGHT wall, LED curtain, power adapter, transport bag.

- Aluminium-Lichtleisten mit einer großen Anzahl von LEDs beleuchten den gesamten Druck gleichmäßig
- die Rückseite des LED-Vorhangs ist lichtundurchlässig, was die Grafik noch besser hervorhebt
- Rahmenbreite - 6,5 cm
- Koffer auf Rollen

Das Set enthält: BACKLIGHT Wand, LED-Vorhang, Netzteil, Transporttasche.

- kurtyna LED pozwala na równomierne podświetlenie wydruku
- tył kurtyny nie przepuszcza światła, co pozwala na jeszcze lepsze podkreślenie grafiki
- aluminiowe listwy świetlne
- profil aluminiowy - 6,5 cm
- torba na kółkach

Zestaw zawiera: ściankę BACKLIGHT, zasilacz, torbę transportową.

Recommended media and printing technology for this system:



Fabric Sublimation printing

LED BOX™ COUNTER



- LED
- 8 cm
ALUMINIUM PROFILE
- SILICONE TAPE MOUNTED PRINTOUT
- NO TOOLS
- DOUBLE SIDED

double-sided LED system
 aluminium profile - 8 cm
 no tools assembly
 silicon tape mounted printout
 The set includes: LED BOX counter, power adapter, transport bag.

beidseitiges LED-System
 Rahmenbreite - 8 cm
 Montage ohne Werkzeug
 Druck auf Stoff, montiert auf Silikonband
 Das Set enthält: Theke LED BOX, Netzteil, Transporttasche.

dwustronny, podświetlany system
 profil aluminiowy - 8 cm
 montaż bez narzędzi
 wydruk na tkaninie montowany na taśmie silikonowej
 Zestaw zawiera: trybunkę LED BOX, zasilacz, torbę transportową.

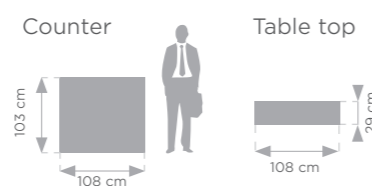

5907451669815 7 kg

Recommended media and printing technology for this system:



LED BOX™ COUNTER WITH SHELF

NEW!



- LED
- 6,5 cm
ALUMINIUM PROFILE
- SILICONE TAPE MOUNTED PRINTOUT
- NO TOOLS



LED counter with practical shelf
 aluminium frame - 6,5 cm
 no tools assembly
 silicon tape mounted printout
 wheeled transport bag
 The set includes: LED BOX with shelf counter, blackback material, power adapter, transport bag.

LED-Theke mit praktischem Regal
 Rahmenbreite - 6,5 cm
 Montage ohne Werkzeug
 Druck auf Stoff, montiert auf Silikonband
 Rolltasche

Das Set enthält: Theke LED-BOX mit Regal, blackback Material, Netzteil, Transporttasche.

trybunka LED z praktyczną półką
 profil aluminiowy - 6,5 cm
 montaż bez narzędzi
 wydruk na tkaninie montowany za pomocą taśmy silikonowej
 torba na kółkach

Zestaw zawiera: trybunkę LED BOX z półką, materiał blackback, zasilacz, torbę transportową.



5907451666142 15 kg

Recommended media and printing technology for this system:



LUNIX™ COUNTER

PREMIUM LINE



- double-sided system
 - **wide aluminium profile (12 cm)**
 - integrated LED lighting
 - no tools assembly
 - silicon tape mounted printout
 - wheeled transport bag
- The set includes: LUNIX™ counter, power adapter, transport bag.

- doppelseitige, auffällige Konstruktion
 - **stabiler Aluminiumrahmen (12 cm)**
 - integrierte LED-Beleuchtung
 - Silikonband befestigte Druck
 - werkzeuglose Montage
 - Tasche auf Rädern
- Das Set enthält: Theke LUNIX™, Netzteil, Transporttasche.

- dwustronny system
 - **szereki profil aluminiowy (12 cm)**
 - zintegrowane oświetlenie LED
 - montaż bez narzędzi
 - wydruk na tkaninie montowany na taśmie silikonowej
 - torba na kółkach
- Zestaw zawiera: trybunkę LUNIX™, zasilacz, torbę transportową.

- LED
- 12 cm WIDE ALUMINIUM PROFILE
- SILICONE TAPE MOUNTED PRINTOUT
- NO TOOLS
- DOUBLE SIDED
- WHEELED BAG

Available table top colours:

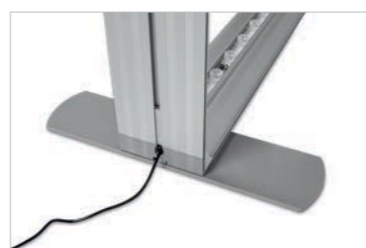

5907451667422 10 kg

Recommended media and printing technology for this system:



PRESTON AUTOMATIC LED COUNTER

- automatic, no tools assembly
 - LED system
 - silicone tape mounted print-out
- The set includes: PRESTON counter, transport bag.

- automatische Montage ohne Werkzeug
 - LED-System
 - Silikonband montiert Ausdruck
- Das Set enthält: Theke PRESTON, Transporttasche.

- automatyczna trybunka LED
 - montaż bez narzędzi
 - wydruk na tkaninie montowanej na taśmie silikonowej
- Zestaw zawiera: trybunkę PRESTON, torbę transportową.

Recommended media and printing technology for this system:

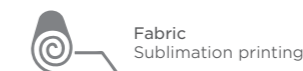

PRESTON AUTOMATIC OVAL LED



- LED
- AUTOMATIC

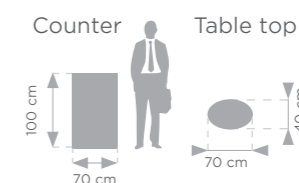

5907451665268 11 kg



PRESTON AUTOMATIC RECTANGLE LED

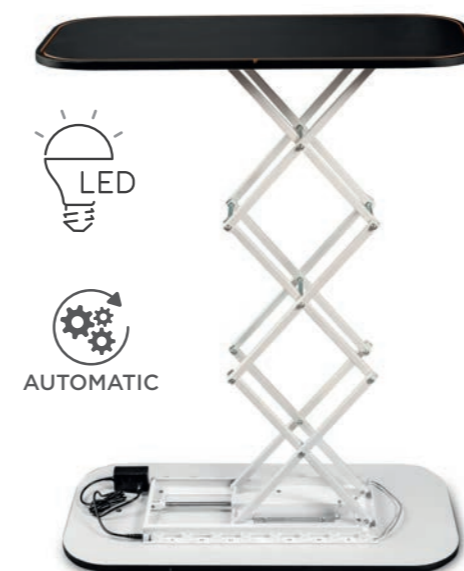

- LED
- AUTOMATIC

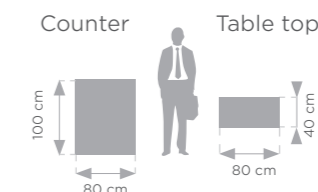

5907451665244 12 kg



BACKLIGHT COUNTER

NEW!

▪ LED curtain enables the entire printout to be evenly illuminated

- aluminium light strips
- aluminium profile - 6,5 cm

The set includes: BACKLIGHT counter, LED curtain, power adapter, transport bag.

▪ Aluminium-Lichtleisten mit einer großen Anzahl von LEDs beleuchten den gesamten Druck gleichmäßig

- Rahmenbreit - 6,5 cm

Das Set enthält: Theke BACKLIGHT, LED-Vorhang, Netzteil, Transporttasche.

▪ kurtyna LED z dużą ilością żarówek pozwala na równomierne oświetlenie wydruku

- aluminiowe listwy świetlne
- profil aluminiowy - 6,5 cm

Zestaw zawiera: trybunkę BACKLIGHT, zasilacz, torbę transportową.



70 LED BULBS



SILICONE TAPE MOUNTED PRINTOUT



NO TOOLS

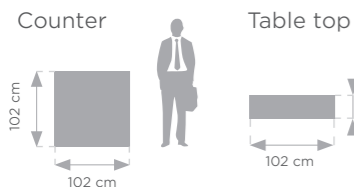

Recommended media and printing technology for this system:



Fabric Sublimation printing

FABRICS FOR PRINTING ON LED SYSTEMS

NEW!

▪ high-quality fabric for LED systems

- diffuses light well
- flexible

▪ hochwertiger Stoff für LED-Systeme

- streut das Licht gut
- flexibel

▪ wysokiej jakości materiał do wydruków montowanych na systemach LED

- dobrze rozprasza światło
- elastyczny

	Width (m)	Barcode
Backlight Samba 180 g	1,6	5904423600418
Backlight Samba 180 g	3,2	5907451664360
Backlit Lumitex 270 g	1,6	5904423600425
Backlit Lumitex 270 g	3,2	5907451664131
Blackback 260 g	3,2	5907451664094



TRADE FAIRS

LUNIX™ EXHIBITION BOOTHS

PREMIUM LINE

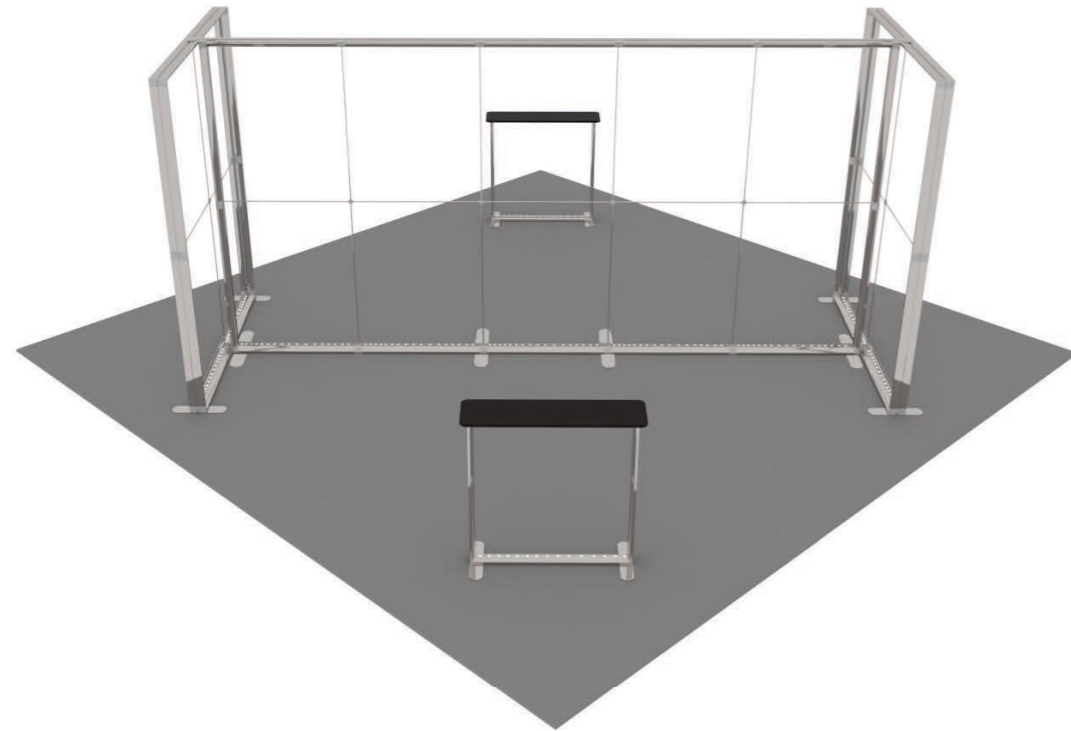

- LED
- 12 cm WIDE ALUMINIUM PROFILE
- MODULAR CONSTRUCTION
- DOUBLE SIDED
- NO TOOLS
- SILICONE TAPE MOUNTED PRINTOUT
- WHEELED BAG

THE LUNIX™ EXHIBITION BOOTH CONSISTS OF THE LUNIX™ SYSTEM (MORE INFO PAGES 14-17) AND THE LUNIX™ COUNTER (MORE INFO - PAGE 22)

- eye-catching LED exhibition stand
 - **wide aluminium profile (12 cm)**
 - no tools assembly
 - silicon tape mounted printout
 - sturdy wheeled transport bag
- The set includes: LUNIX™ system, LUNIX™ counter, transport bags, assembly accessories.

- auffällige LED-Messestand
- **breiter Aluminiumrahmen (12 cm)**
- werkzeuglose Montage
- Druck auf Stoff, montiert auf Silikonband
- robuste Transporttasche auf Rädern

Das Set enthält: LUNIX™-System, LUNIX™-Theke, Transporttasche, Montagehilfsmittel.

- spektakularne, podświetlane stoisko targowe
- **szeroki profil aluminiowy (12 cm)**
- montaż bez narzędzi
- wydruk na tkaninie montowanej na taśmie silikonowej
- torba na kółkach

Zestaw zawiera: system LUNIX™, trybunkę LUNIX™, torbę transportową, akcesoria montażowe.

16 m ² /island	5907451667996
25 m ² /island	5907451667989
36 m ² /island	5907451667972
9 m ² /peninsula	5907451667965
12 m ² /peninsula	5907451667941
15 m ² /peninsula	5907451667934
16 m ² /peninsula	5907451667958
18 m ² /peninsula	5907451667910
24 m ² /peninsula/1 counter	5907451667927
24 m ² /peninsula/2 counters	5907451667903
9 m ² /corner	5907451667897
15 m ² /corner	5907451667859
25 m ² /corner	5907451667873

EXAMPLES OF THE LUNIX™ EXHIBITION BOOTHS



Recommended media and printing technology for this system:



Fabric Sublimation printing

LUNIX™ EXHIBITION BOOTHS ACCESSORIES

MONITOR HOLDER

A special monitor holder allows additional multimedia presentation. This is an ideal alternative to traditional posters or banners, which increases the efficiency of the entire booth.

Eine spezielle Monitorhalterung ermöglicht eine zusätzliche multimediale Präsentation. Dies ist die ideale Alternative zu herkömmlichen Plakaten oder Bannern, was die Effizienz des gesamten Standes erhöht.

Specjalny uchwyt na monitor pozwala na dodatkową, multimedialną prezentację oferty. To idealna alternatywa dla tradycyjnych plakatów czy banerów, która zwiększa efektywność całego stoiska.



LOCKER SET

The illuminated storage room with a code lock is a great solution to store materials needed during trade fairs or other promotional events.

Das beleuchtete Kabine mit Codeschloss ist eine hervorragende Lösung für die Aufbewahrung von Materialien, die für Messen oder andere Werbeveranstaltungen benötigt werden.

Podświetlany schowek z zamkiem na kod to świetne rozwiązanie do przechowywania materiałów potrzebnych podczas targów czy innych wydarzeń promocyjnych.



SHELVES SYSTEM

The shelves system makes the LUNIX™ products even more functional. The shelves can be mounted horizontally or diagonally.

Mit dem LUNIX™ Regalsystem ist LUNIX™ noch funktionaler für Messen oder Promotionen. Die Regale können waagrecht oder diagonal montiert werden.

Dzięki systemowi półek LUNIX™ staje się jeszcze bardziej funkcjonalnym systemem targowym czy promocyjnym. Półki możesz zamontować w poziomie lub na ukos.



ROOF

A practical accessory for the LUNIX™ system. Similar to the LUNIX™ system, the product features a high-quality, aluminium construction with a wide profile (12 cm), integrated LED lighting and tool-free assembly.

Ein praktisches Zubehör für das LUNIX™-System. Ähnlich wie das LUNIX™-System zeichnet sich das Produkt durch eine hochwertige Aluminiumkonstruktion mit einem breiten Profil (12 cm), integrierter LED-Beleuchtung und werkzeugloser Montage aus.

Praktyczne akcesorium do systemu LUNIX™. Produkt, identycznie jak system LUNIX™, cechuje wbudowane oświetlenie LED, szeroki profil aluminiowy (12 cm), dwustronna grafika oraz montaż bez narzędzi.



SAVER CASE

NEW!

wheeled trade fair case with counter option
 ■ large size and straps securing the contents
 ■ practical wheels and a handle ensures easy transport
 ■ fabric printout
 The set includes: Saver case, individual carton box.

Transportkoffer auf Rollen mit Thekenfunktion
 ■ großes Format und Gurte zur Sicherung des Inhalts
 ■ praktische Rollen und ein Griff sorgen für einfachen Transport
 ■ Stoffdruck
 Das Set enthält: Saver case, Einzelkarton.

walizka targowa na kółkach z opcją trybunki
 ■ duże rozmiary i pasy zabezpieczające zawartość
 ■ praktyczne kółeczka i rączka ułatwiają przemieszczanie całego systemu
 ■ wydruk na tkaninie
 Zestaw zawiera: Saver case, indywidualny karton.

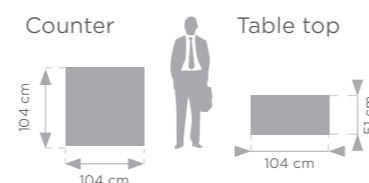

	capacity		
104x51x104 cm	80 kg	5907451668511	11 kg

Recommended media and printing technology for this system:

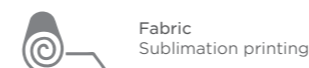

TRANSPORT CASES

NEW!

- practical case for advertising materials
- product made of HDPE material - a very durable high-density polyethylene
- straps protecting the contents inside and outside
- practical wheels and a handle ensure easy transport

The set includes: case, individual carton box.





- praktischer Koffer für Werbematerialien
- Produkt aus HDPE - einem sehr langlebigen, hochdichten Polyethylen
- große Abmessungen sowie Innen- und Außenriemen zum Schutz des Inhalts
- praktische Rollen und ein Griff erleichtern den Transport des gesamten Systems

Das Set enthält: Messekoffer, Einzelkarton.



- praktyczna walizka na materiały reklamowe
- produkt wykonany z materiału HDPE - bardzo wytrzymałego polietylenu o wysokiej gęstości
- duże rozmiary i pasy zabezpieczające zawartość w środku oraz na zewnątrz
- praktyczne kółeczka i rączka ułatwiają przemieszczanie całego systemu

Zestaw zawiera: walizkę, indywidualny karton.

	capacity		
S - 134x43x27 cm	102 L	5907451660362	6 kg
L - 165x40x27 cm	105 L	5907451660393	11 kg



ROLL UP

ROLL UPS COMPARISON

Type of bags	
S	Standard bag
SL	Standard long zip bag
PL	Premium long zip bag
P	Premium bag

Product name	Side view	Foot view	Size	KG	Single-sided (S) or double-sided (D) print
Compact			80x200	1,5	S
			85x200	1,56	S
			100x200	1,73	S
Standard			85x200	1,64	S
			100x200	2	S
			120x200	2,4	S
Standard Black			85x200	1,64	S
			100x200	1,9	S
			120x200	2,4	S
Standard Plus			85x200	1,6	S
			100x200	2	S
			120x200	2,4	S
			150x200	3,05	S
Classic			80x200	1,85	S
			85x200	2	S
			100x200	2,24	S
			120x200	2,87	S
			150x200	3,46	S
Basic			80x200	1,9	S
			85x200	2,1	S
			100x200	2,5	S
			120x200	3	S
			150x200	3,7	S
Premium			80x200	2	S
			85x200	2,2	S
			100x200	2,7	S
			120x200	3,5	S
			150x200	4	S
Pro			85x200	2,7	S
			100x200	3,1	S
			120x200	3,7	S
			150x200	4,7	S
			200x200	6,2	S
Exclusive			85x200	2,7	S
			100x200	3,2	S
			120x200	3,8	S
			150x200	4,8	S
			200x200	6,4	S
Exclusive Black			85x200	2,7	S
			100x200	3,2	S
			120x200	3,8	S
			150x200	4,8	S
			200x200	6,4	S
Exclusive Plus			85x220	4,2	S
			100x220	5,2	S
			120x220	6,9	S
			150x220	7,4	S
Clip			85x220	4	S
			100x220	4,3	S
Wave			85x220	2,6	S
			100x220	3,1	S
			120x220	3,7	S
			150x220	4,6	S
Twin			85x200	4	D
			100x200	4,7	D

Number of poles	Telescopic pole	Adhesive on bottom	Snap on bottom	Number of feet	Type of bag	Individual carton box
1		•		2	S	
1		•		2	S	
1		•		2	S	
1		•		2	SL	•
1		•		2	SL	•
2		•		2	SL	•
2		•		2	SL	•
1		•		2	SL	•
1		•		2	SL	•
1		•		2	SL	•
2		•		2	SL	•
2		•		2	SL	•
1		•		2	PL	•
1		•		2	PL	•
1		•		2	PL	•
2		•		2	PL	•
2		•		2	PL	•
1		•		2	PL	•
1		•		2	PL	•
1		•		2	PL	•
2		•		2	PL	•
2		•		2	PL	•
1		•		1	PL	•
1		•		1	PL	•
2		•		2	PL	•
2		•		2	PL	•
2		•		2	PL	•
1		•		2	PL	•
1		•		2	PL	•
2		•		2	PL	•
2		•		2	PL	•
1	•	•			PL	•
1	•	•			PL	•
2	•	•			PL	•
2	•	•			PL	•
1	•		•		PL	•
1	•		•		PL	•
1	•		•		PL	•
2	•		•		PL	•
2	•		•		PL	•
1		•			S	•
1		•			S	•

COMPACT

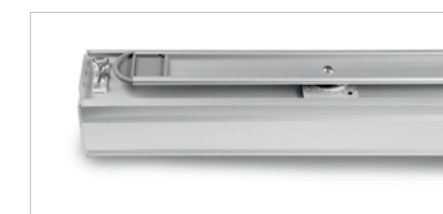
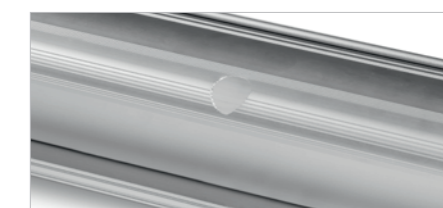
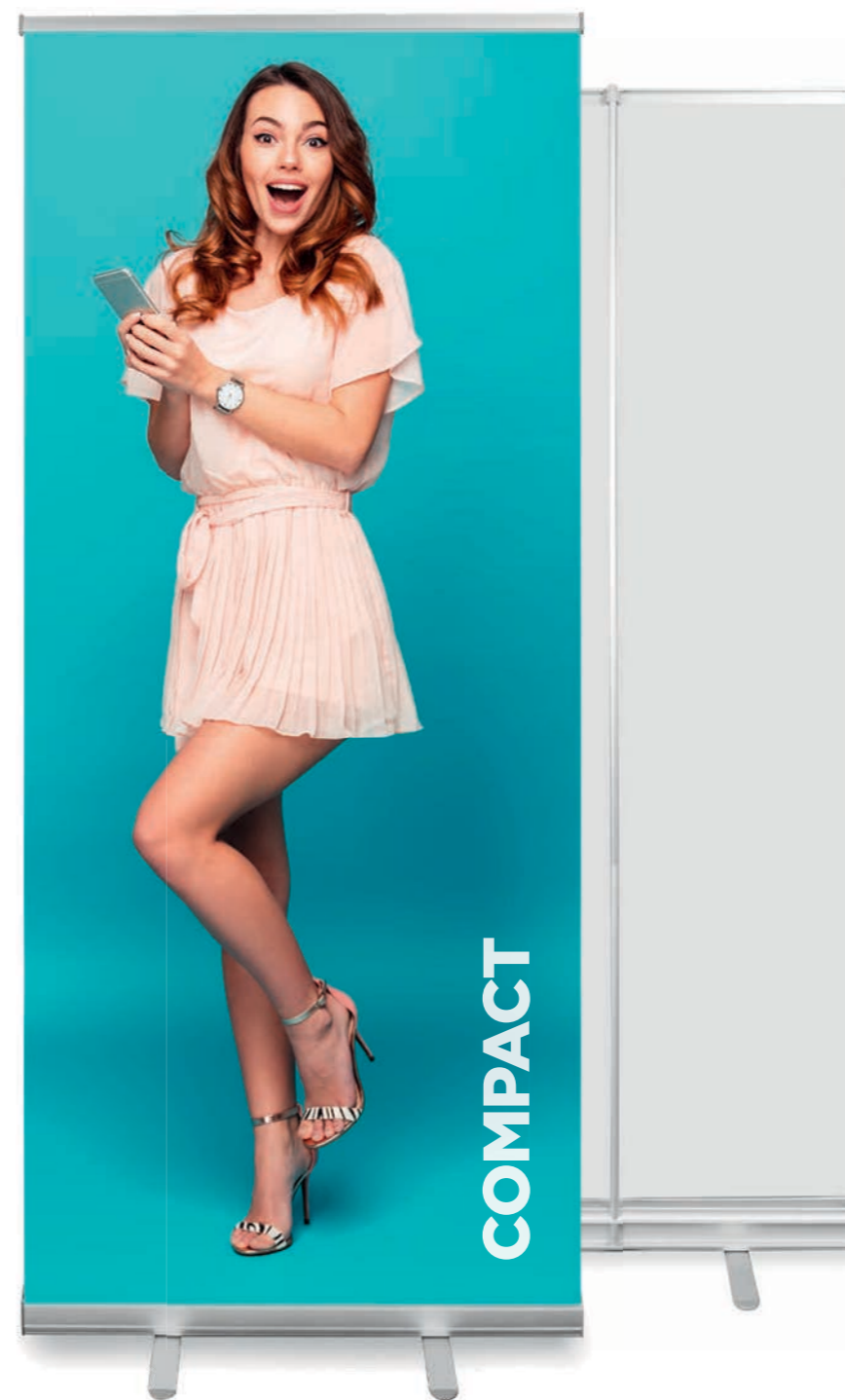

- price leader!
- small, compact and easy to carry
- cassette dimension reduced from 9,3 to 8,3 cm
- "Express Clip" top bar - quick and easy print assembly
- economy class product, valued for big adv campaigns

This set includes: Compact roll up cassette, pole, "Express Clip" top bar with 3M adhesive tape, bag with business card pocket.

- Preisführer unter den Roll-Ups!
- klein, kompakt und leicht zu tragen.
- Durchmesser der Kassette von 9,3 auf 8,3 cm reduziert
- "Express Clip" obere Leiste - schnelle und einfache Druckmontage
- Economy Class-Produkt, das für große Adv-Kampagnen geschätzt wird

Das Set enthält: Compact Roll-Up-Kassette, Mast, Einrastleiste "Express Clip" mit 3M Klebeband, Transporttasche mit Fenster für Visitenkarte.

- lider cenowy!
- mały, poręczny i łatwy w transporcie
- średnica kasety zredukowana z 9,3 do 8,3 cm
- listwa „Express Clip” – błyskawiczny i łatwy montaż wydruku
- produkt ekonomiczny, ceniony przy dużych kampaniach

Zestaw zawiera: kasetę typu Compact, maszt, listwę zatrząskową „Express Clip” z taśmą 3M, torbę transportową z okienkiem na wizytówkę.

80×200	5907451662762	1,5 kg
85×200	5907451660010	1,56 kg
100×200	5907451660027	1,73 kg

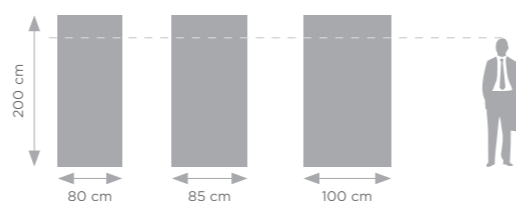

Recommended media and printing technology for this system:



STANDARD



LONG ZIP BAG

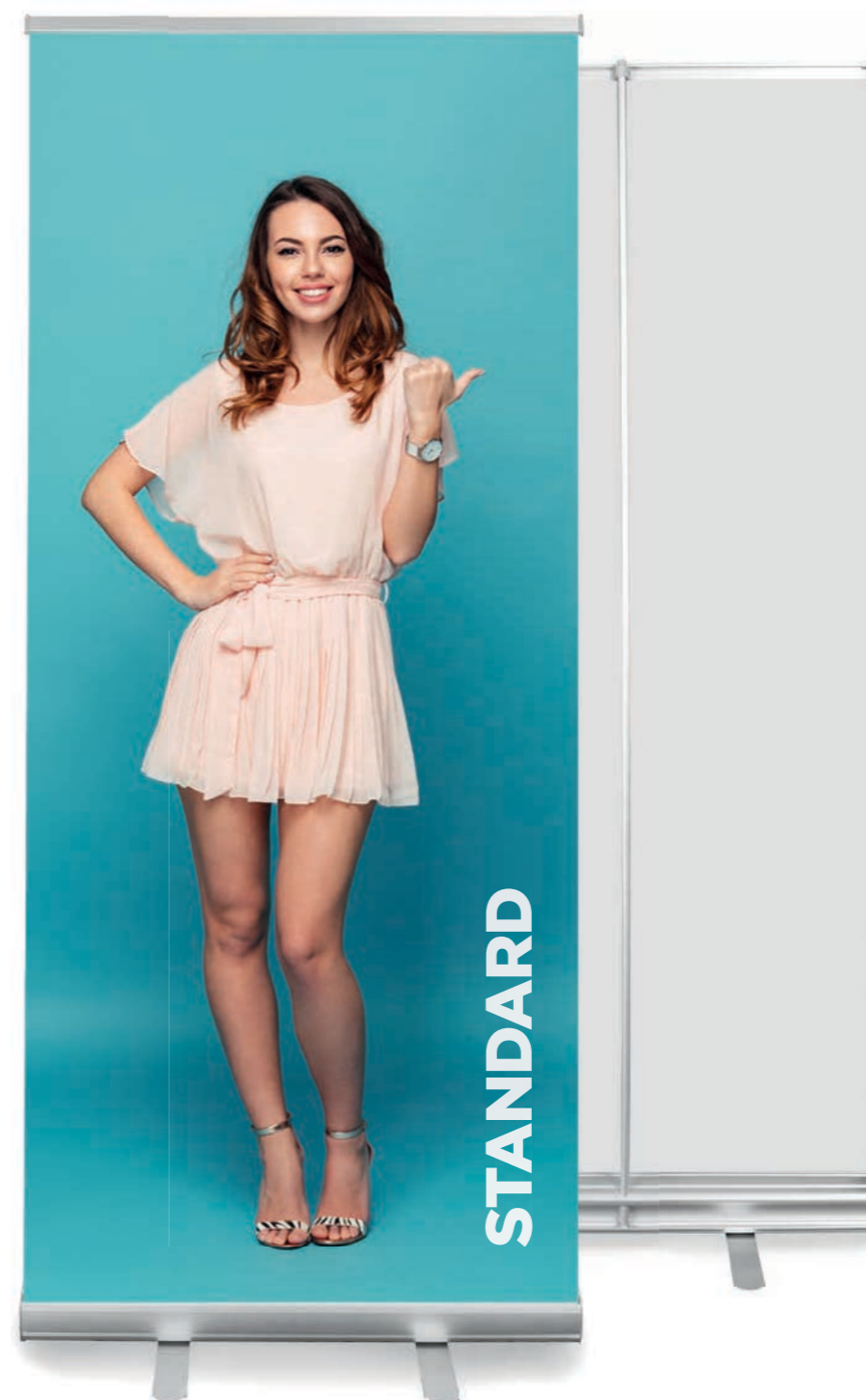

- bestseller on many markets
- stable, strong construction, 100% made of anodized aluminum
- "Express clip" top bar - quick and easy print assembly
- reinforced rear panel with the pole stabilizer
- transport bag with a long zipper

This set includes: Standard roll up cassette, pole (sizes 120×200 and 150×200 include 2 poles), "Express clip" top bar, 3M adhesive tape, bag with a business card pocket, individual box.

- Bestseller in vielen Märkten
- stabile Konstruktion aus 100% eloxiertem Aluminium
- "Express Clip" obere Leiste - schnelle und einfache Druckmontage
- verstärkte Rückwand mit Maststabilisator
- Tasche mit langem Reißverschluss

Das Set enthält: Standard Roll-Up-Kassette, Mast (die Größen 120×200 und 150×200 haben zwei Masten), „Express Clip“ - obere Klemmleiste, 3M-Klebeband, Transporttasche mit Fenster für Visitenkarte, Einzelkarton.

- bestseller na wielu rynkach
- mocna konstrukcja w 100% z anodowanego aluminium
- listwa „Express Clip” - błyskawiczny i łatwy montaż wydruku
- wzmocniona ścianka tylna ze stabilizatorem masztu
- torba z długim zapięciem

Zestaw zawiera: kasetę typu Standard, maszt (rozmiary 120×200 i 150×200 posiadają dwa maszty), listwę zatrzaskową „Express clip”, taśmę 3M, torbę transportową z okienkiem na wizytówkę, indywidualny karton.

85×200	5907451660034	1,64 kg
100×200	5907451660041	2 kg
120×200	5907451660058	2,4 kg
150×200	5907451660065	3,05 kg

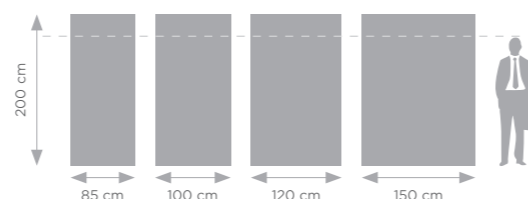

Recommended media and printing technology for this system:



Stoplight
Solvent, UV, Latex



Coated Frontlit
Solvent, UV, Latex



STANDARD BLACK



LONG ZIP BAG

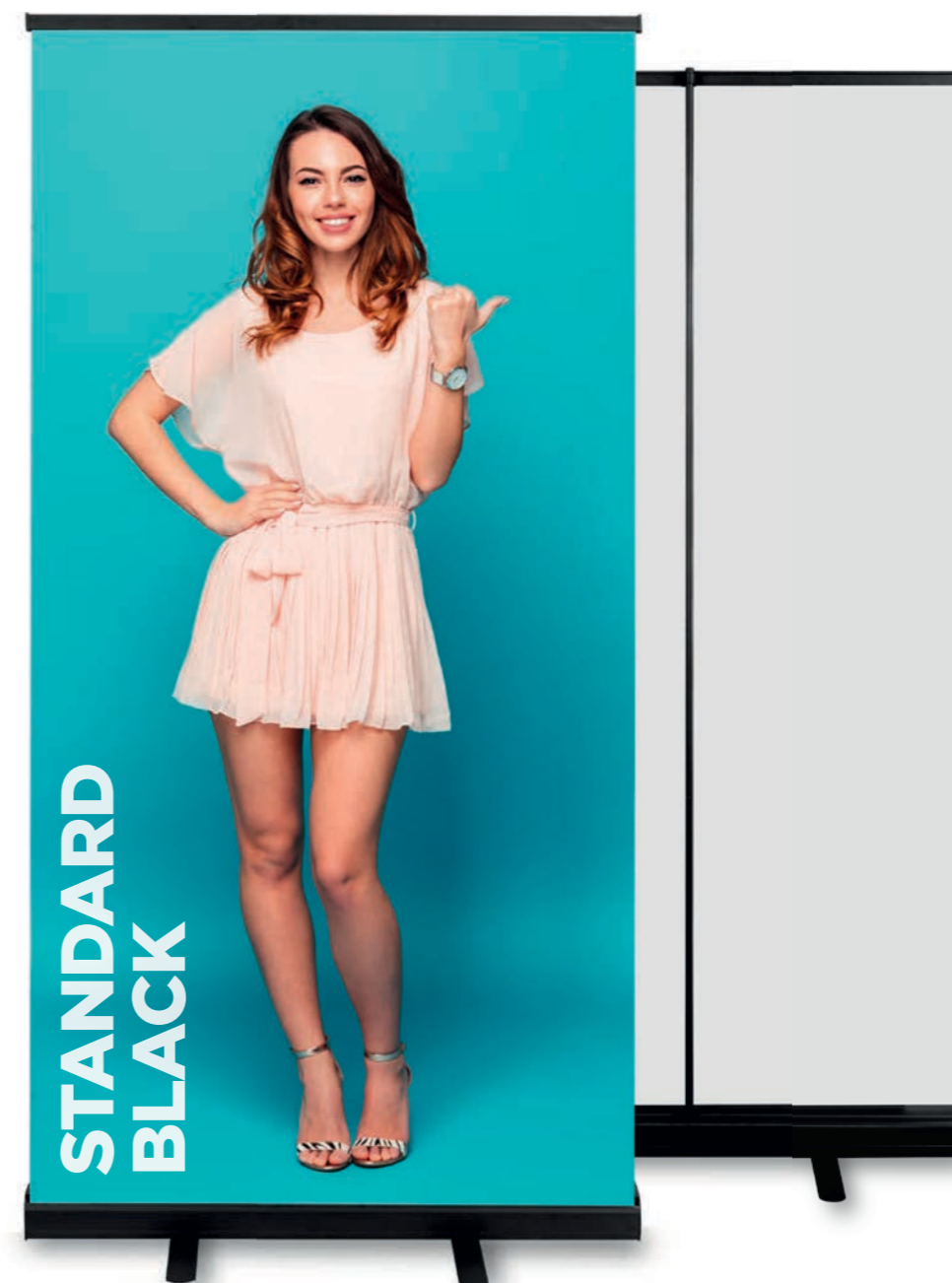

- powder painted black (mat)
- stable, strong construction, 100% made of anodized aluminum
- the pole stabilizer
- "Express clip" top bar – quick and easy print assembly
- transport bag with a long zipper

This set includes: Standard Black roll up cassette, pole, "Express clip" top bar, 3M adhesive tape, bag with a business card pocket, individual box.

- matte schwarze Farbe
- stabile Konstruktion aus 100% eloxiertem Aluminium
- Maststabilisator
- "Express Clip" obere Leiste – schnelle und einfache Druckmontage
- Tasche mit langem Reißverschluss

Das Set enthält: Standard Black Roll-Up-Kassette, Mast, „Express Clip“ – obere Klemmleiste, 3M-Klebeband, Transporttasche mit Fenster für Visitenkarte, Einzelkarton.

- kolor czarny mat (malowany proszkowo)
- mocna konstrukcja w 100% z anodowanego aluminium
- stabilizator masztu
- listwa „Express Clip” – błyskawiczny i łatwy montaż wydruku
- torba z długim zapięciem

Zestaw zawiera: kasetę typu Standard Black, maszt, listwę zatrzaskową „Express clip”, taśmę 3M, torbę transportową z okienkiem na wizytówkę, indywidualny karton.

85x200	5907451662472	1,64 kg
100x200	5907451662700	2 kg

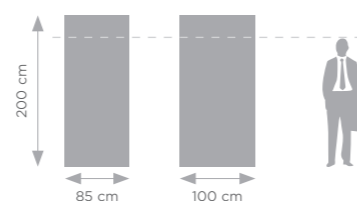

Recommended media and printing technology for this system:



STANDARD PLUS

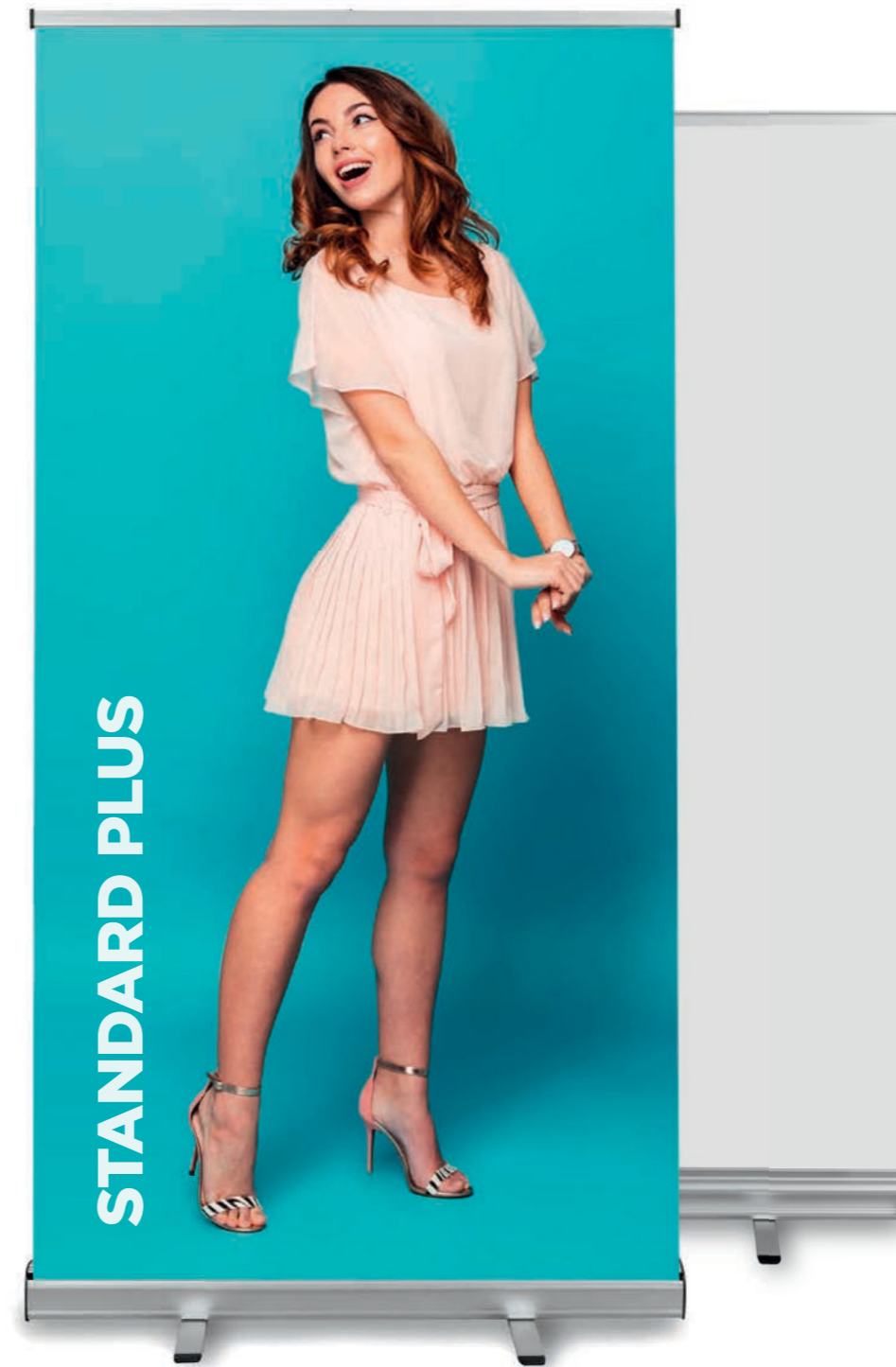

- plastic sides of the cassette, more resistant to dents
- reinforced rear panel with the pole stabilizer
- "Express Clip" top bar – quick and easy print assembly
- transport bag with a long zipper

This set includes: Standard Plus roll up cassette, pole (sizes 120×200 and 150×200 include 2 poles), "Express clip" top bar, 3M adhesive tape, bag with a business card pocket, individual box.

- Seitenwände aus Kunststoff, widerstandsfähiger gegen Dellen
- verstärkte Rückwand mit Maststabilisator
- "Express Clip" obere Leiste – schnelle und einfache Druckmontage
- Tasche mit langem Reißverschluss

Das Set enthält: Standard Plus Roll-Up-Kassette, Mast (die Größen 120×200 und 150×200 haben zwei Masten), „Express Clip“ – obere Klemmleiste, 3M-Klebeband, Transporttasche mit Fenster für Visitenkarte, Einzelkarton.

- boki kasety z tworzywa sztucznego, bardziej wytrzymałe na wgniecenia
- wzmocniona ścianka tylna ze stabilizatorem masztu
- listwa „Express Clip” – błyskawiczny i łatwy montaż wydruku
- torba z długim zapięciem

Zestaw zawiera: kasetę typu Standard Plus, maszt (rozmiary 120×200 i 150×200 posiadają dwa maszty), listwę zatraskową „Express clip”, taśmę 3M, torbę transportową z okienkiem na wizytówkę, indywidualny karton.

85×200	5907451662427	1,6 kg
100×200	5907451662434	2 kg
120×200	5907451662724	2,4 kg
150×200	5907451662731	3,05 kg

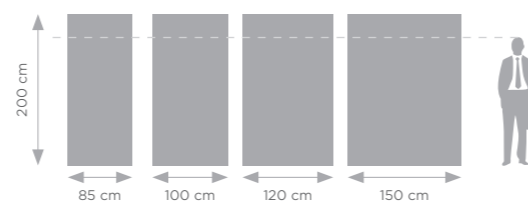

Recommended media and printing technology for this system:



CLASSIC



LONG ZIP BAG

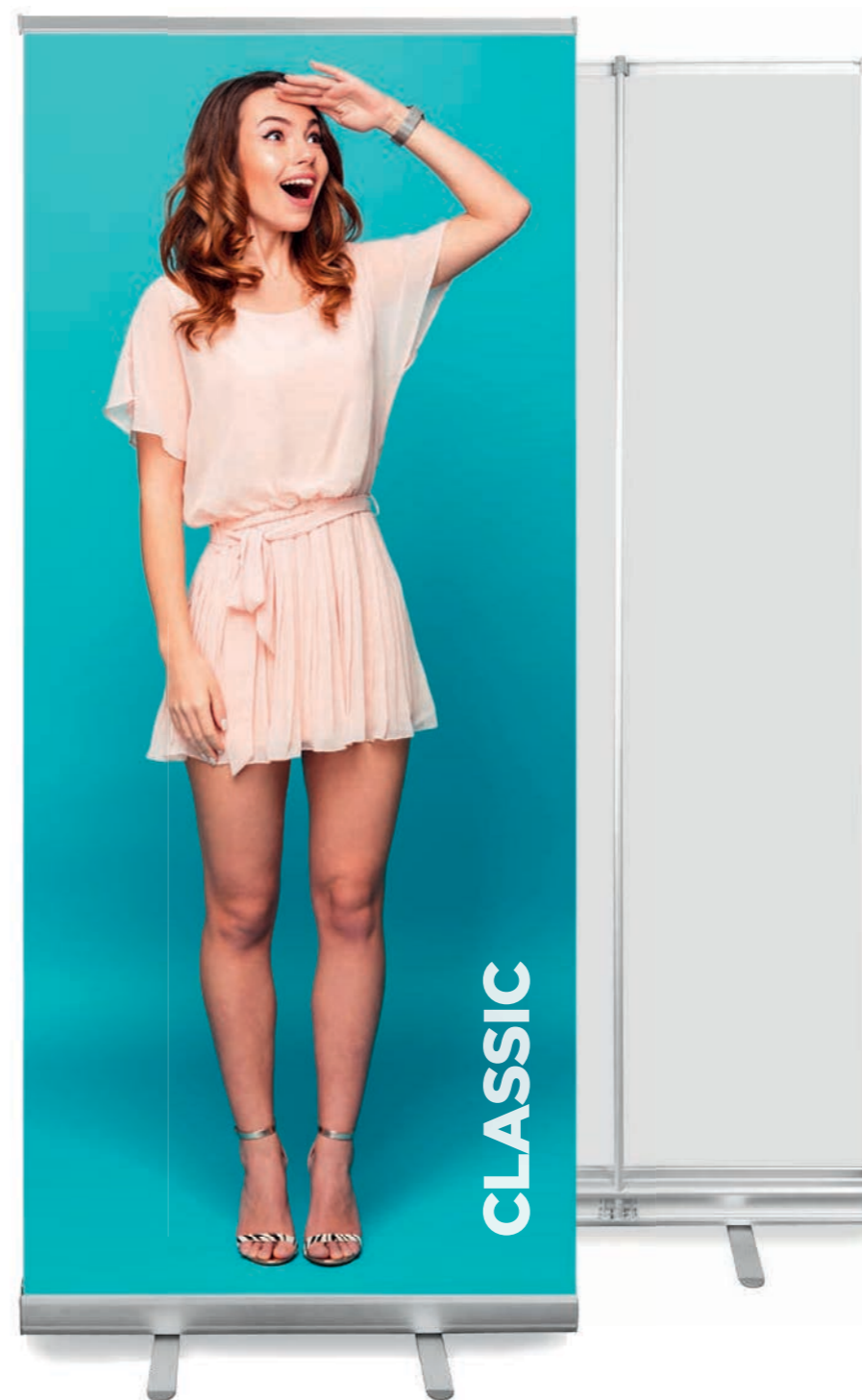

- bestseller on many markets
- reinforced rear panel with the pole stabilizer
- "Express Clip" top bar – quick and easy print assembly
- plastic foot tips
- transport bag with a long zipper

This set includes: Classic roll up cassette, pole (sizes 120×200 and 150×200 include 2 poles), "Express Clip" top bar, 3M adhesive tape, bag with a business card pocket, individual box.

- Bestseller in vielen Märkten
- verstärkte Rückwand mit Maststabilisator
- "Express Clip" obere Leiste – schnelle und einfache Druckmontage
- Plastikfußspitzen
- Tasche mit langem Reißverschluss

Das Set enthält: Classic Roll-Up-Kassette, Mast (die Größen 120×200 und 150×200 haben zwei Masten), „Express Clip“ – obere Klemmleiste, 3M-Klebeband, Transporttasche mit Fenster für Visitenkarte, Einzelkarton.

- bestseller na wielu rynkach
- wzmocniona tylna ścianka ze stabilizatorem masztu
- listwa „Express Clip” – błyskawiczny i łatwy montaż wydruku
- plastikowe końcówki nóżek
- torba z długim zapięciem

Zestaw zawiera: kasetę typu Classic, maszt (rozmiary 120×200 i 150×200 posiadają dwa maszty), listwę zatrzaskową „Express clip”, taśmę 3M, torbę transportową z okienkiem na wizytówkę, indywidualny karton.

80×200	5907451660638	1,9 kg
85×200	5907451660072	2 kg
100×200	5907451660089	2,2 kg
120×200	5907451660096	2,9 kg
150×200	5907451660102	3,4 kg

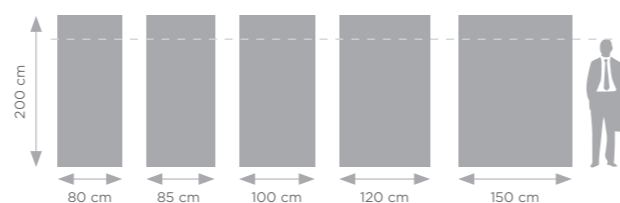

Recommended media and printing technology for this system:



BASIC



LONG ZIP
BAG

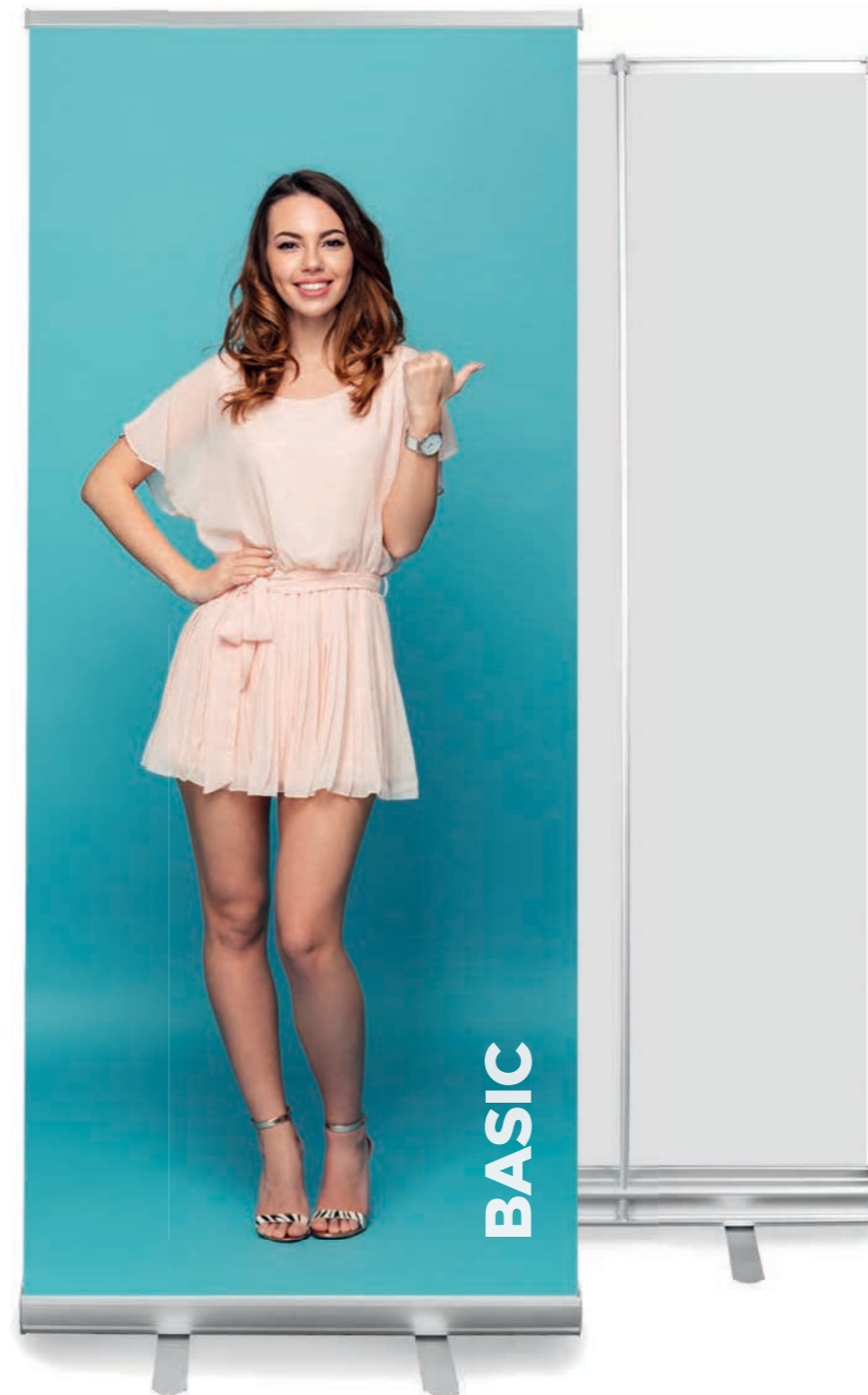

- stable, strong construction, 100% made of anodized aluminum
- the pole stabilizer
- "Express Clip" top bar - quick and easy print assembly
- padded transport bag with a long zipper and trimming

This set includes: Basic roll up cassette, pole (sizes 120x200 and 150x200 include 2 poles), "Express Clip" top bar, 3M adhesive tape, bag with a business card pocket, individual carton box.

- stabile Konstruktion aus 100% eloxiertem Aluminium
- Maststabilisator
- "Express Clip" obere Leiste - schnelle und einfache Druckmontage
- gepolsterte Tasche mit langem Reißverschluss

Das Set enthält: Basic Roll-Up-Kassette, Mast (die Größen 120x200 und 150x200 haben zwei Masten), „Express Clip“ - obere Klemmleiste, 3M-Klebeband, Transporttasche mit Fenster für Visitenkarte, Einzelkarton.

- solidna, aluminiowa konstrukcja
- stabilizator masztu
- listwa „Express Clip” - błyskawiczny i łatwy montaż wydruku
- wyściełana, gustowna torba z zapięciem long zip

Zestaw zawiera: kasetę typu Basic, maszt (rozmiary 120x200 i 150x200 posiadają dwa maszty), listwę zatrzaskową „Express Clip”, taśmę 3M, torbę transportową z okienkiem na wizytówkę, indywidualny karton.

80x200	5907451668191	1,9 kg
85x200	5907451668061	2,1 kg
100x200	5907451668078	2,5 kg
120x200	5907451668085	3 kg
150x200	5907451668092	3,7 kg

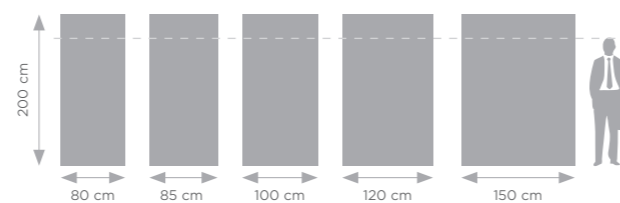

Recommended media and printing technology for this system:



PREMIUM



LONG ZIP BAG

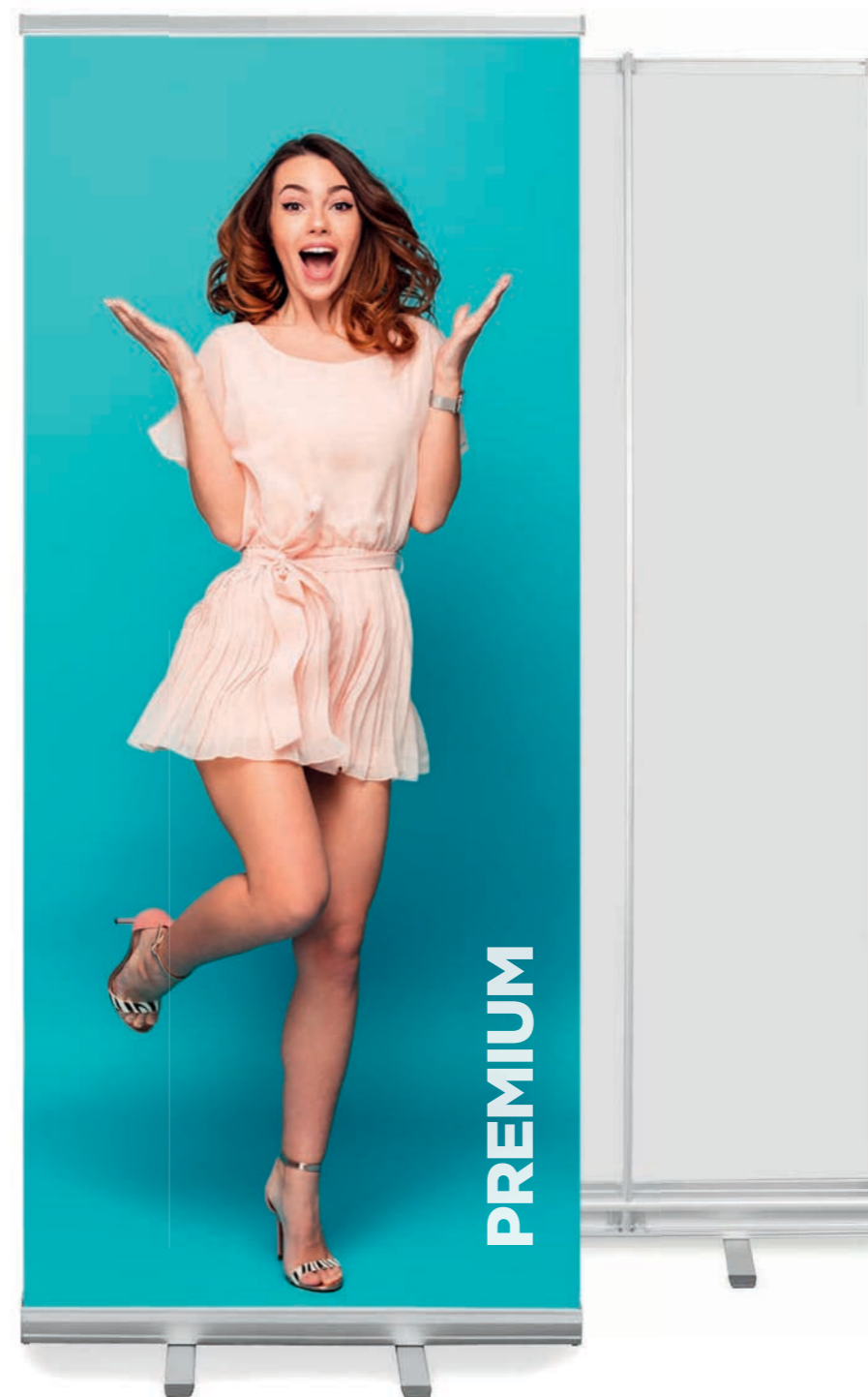

- solid, heavy construction
- reinforced rear panel with the pole stabilizer
- "Express Clip" top bar - quick and easy print assembly
- foot tips and side walls in dark elegant colour
- padded transport bag with a long zipper and trimming

This set includes: Premium roll up cassette, pole (sizes 120x200 and 150x200 include 2 poles), „Express Clip“ top bar, 3M adhesive tape, bag with a business card pocket, individual carton box.

- robuste, schwere Konstruktion
- verstärkte Rückwand mit Maststabilisator
- "Express Clip" obere Leiste - schnelle und einfache Druckmontage
- Seiten und Standfußenden in einer eleganten dunklen Farbe (Anthrazit)
- gepolsterte Tasche mit langem Reißverschluss

Das Set enthält: Premium Roll-Up-Kassette, Mast (die Größen 120x200 und 150x200 haben zwei Masten), „Express Clip“ - obere Klemmleiste, 3M-Klebeband, Transporttasche mit Fenster für Visitenkarte, Einzelkarton.

- solidna, ciężka konstrukcja
- wzmocniona tylna ścianka ze stabilizatorem masztu
- błyskawiczny montaż grafiki i ulepszony system zwijający
- zakończenia nóg i boki w eleganckim ciemnym kolorze
- wyściełana, gustowna torba z zapięciem long zip

Zestaw zawiera: kasetę typu Premium, maszt (rozmiary 120x200 i 150x200 posiadają dwa maszty), listwę zatrzaskową „Express Clip”, taśmę 3M, torbę transportową z okienkiem na wizytówkę, indywidualny karton.

80x200	5907451668009	2 kg
85x200	5907451660119	2,2 kg
100x200	5907451660126	2,7 kg
120x200	5907451660133	3,5 kg
150x200	5907451660140	4 kg

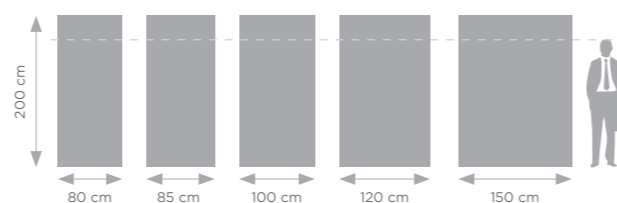

Recommended media and printing technology for this system:



PRO

PREMIUM LINE



LONG ZIP BAG



- 200×200 cm size available
- the thickest aluminium profile among standard cassettes
- heavy and very stable product
- "Express Clip" top bar - quick and easy print assembly
- padded transport bag with a long zipper and trimming

This set includes: Pro roll up cassette, pole (sizes 120×200 and 150×200 include 2 poles, size 200×200 includes 3 poles), "Express Clip" top bar, 3M adhesive tape, bag with a business card pocket, individual box.

- 200×200 cm Größe verfügbar
- dickstes Aluminiumprofil unter den Standardkassetten
- hohes Gewicht und Stabilität des Systems
- "Express Clip" obere Leiste - schnelle und einfache Druckmontage
- gepolsterte Tasche mit langem Reißverschluss

Das Set enthält: Pro Roll-Up-Kassette, Mast (die Größen 120×200 und 150×200 haben zwei Masten, 200×200 hat 3 Masten), „Express Clip“ - obere Klemmleiste, 3M-Klebeband, Transporttasche mit Fenster für Visitenkarte, Einzelkarton.

- dostępny również w rozmiarze 200×200 cm
- najgrubszy profil aluminiowy spośród standardowych kaset
- ciężka, bardzo solidna kasetka
- listwa „Express Clip” - błyskawiczny i łatwy montaż wydruku
- wyściełana torba z długim zapięciem

Zestaw zawiera: kasetę typu Pro, maszt (rozmiary 120×200 i 150×200 posiadają dwa maszty, rozmiar 200×200 posiada trzy maszty), listwę zatrzaskową „Express clip”, taśmę 3M, torbę transportową z okienkiem na wizytówkę, indywidualny karton.

85×200	5907451660584	2,7 kg
100×200	5907451660591	3,1 kg
120×200	5907451660607	3,7 kg
150×200	5907451660614	4,7 kg
200×200	5907451660621	6,2 kg

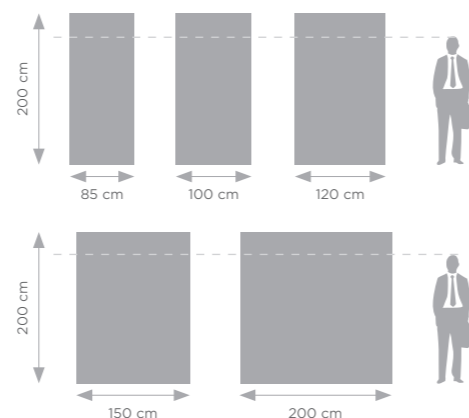

Recommended media and printing technology for this system:

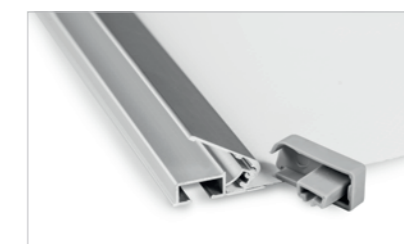
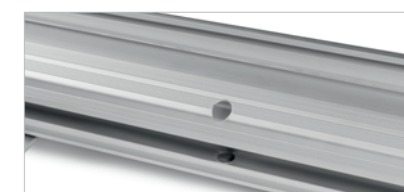
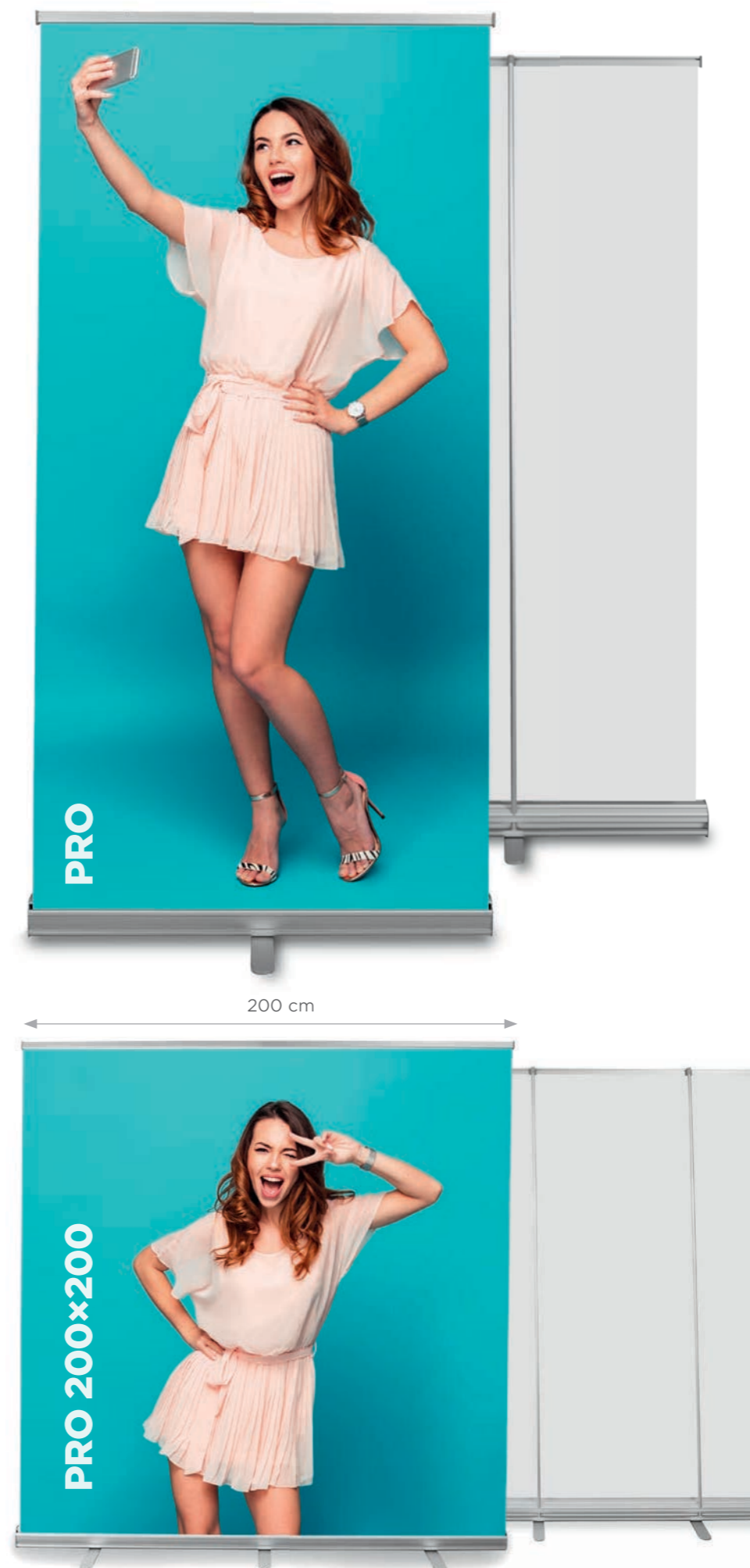

EXCLUSIVE

PREMIUM LINE

BEST SELLER

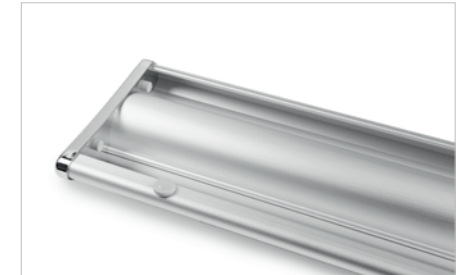
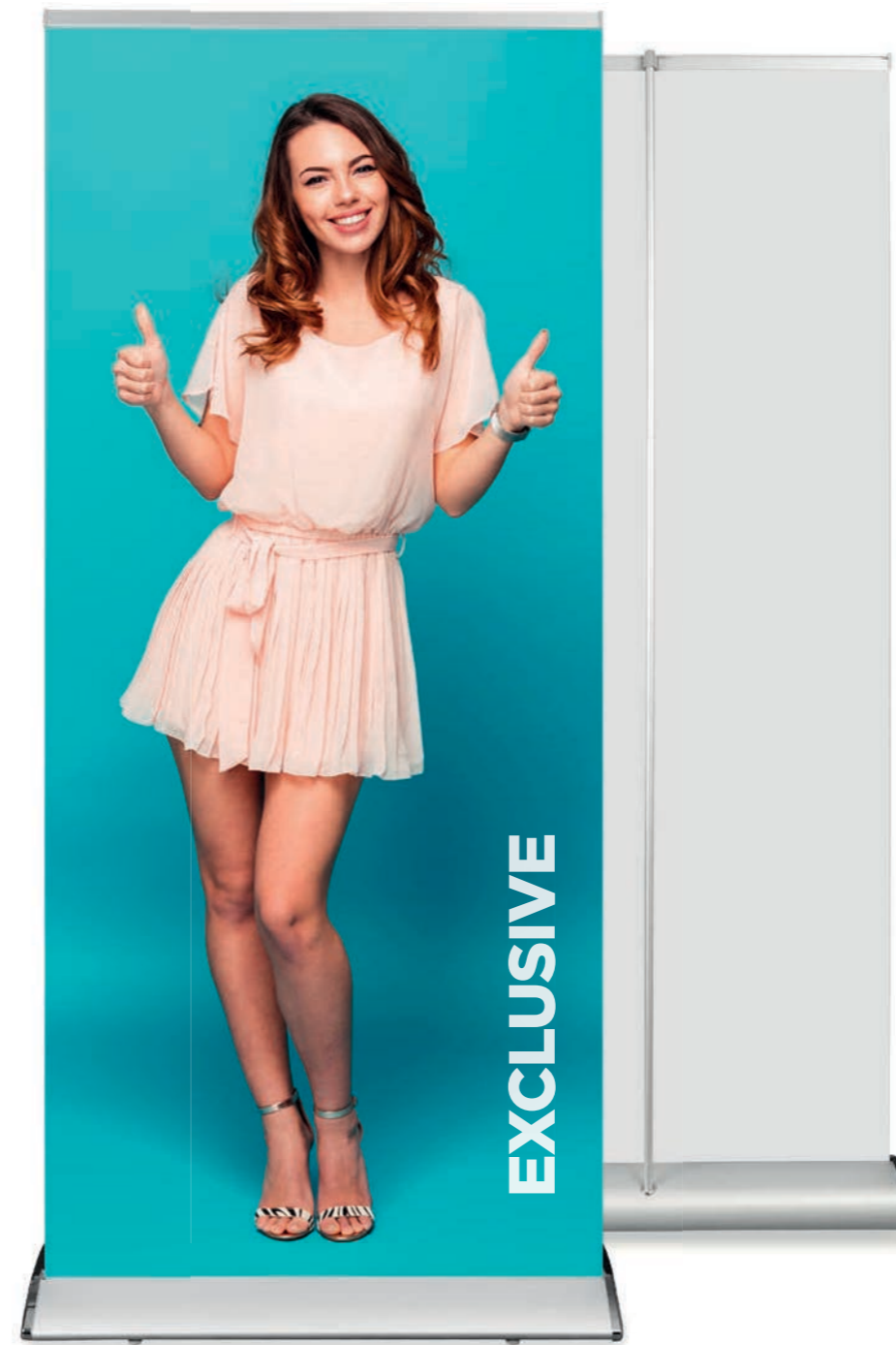

- elegant appearance
- 200x200 cm size available
- heavy and very stable product
- "Express Clip" top bar – quick and easy print assembly
- elegant carrying bag with a long zipper

This set includes: Exclusive roll up cassette, pole (sizes 120x200 and 150x200 include 2 poles, size 200x200 includes 3 poles), "Express Clip" top bar, 3M adhesive tape, bag with a business card pocket, individual box.

- elegantes Aussehen
- 200x200 cm Größe verfügbar
- hohes Gewicht und Stabilität des Systems
- "Express Clip" obere Leiste – schnelle und einfache Druckmontage
- schicke Tasche mit langem Reißverschluss

Das Set enthält: Exclusive Roll-Up-Kassette, Mast (die Größen 120x200 und 150x200 haben zwei Masten, 200x200 hat 3 Masten), „Express Clip“ – obere Klemmleiste, 3M-Klebeband, Transporttasche mit Fenster für Visitenkarte, Einzelkarton.

- wyjątkowo elegancki wygląd
- dostępny również w rozmiarze 200x200 cm
- bardzo ciężka, stabilna kasetta
- listwa „Express Clip” – błyskawiczny i łatwy montaż wydruku
- elegancka torba z długim zamknięciem

Zestaw zawiera: kasetę typu Exclusive, maszt (rozmiary 120x200 i 150x200 posiadają dwa maszty, rozmiar 200x200 posiada trzy maszty), listwę zatrzaskową „Express clip”, taśmę 3M, torbę transportową z okienkiem na wizytówkę, indywidualny karton.

Size	Barcode	Weight
85x200	5907451660492	2,7 kg
100x200	5907451660508	3,2 kg
120x200	5907451660515	3,8 kg
150x200	5907451660522	4,8 kg
200x200	5907451660539	6,4 kg

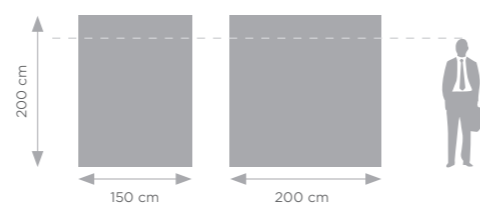
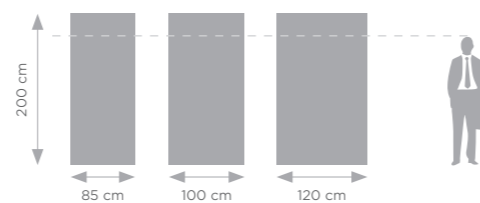

Recommended media and printing technology for this system:



EXCLUSIVE BLACK

PREMIUM LINE

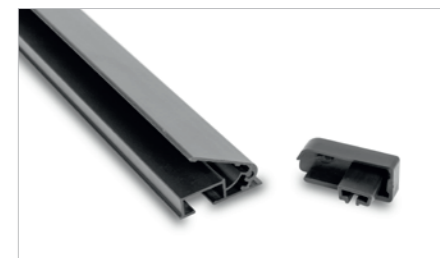
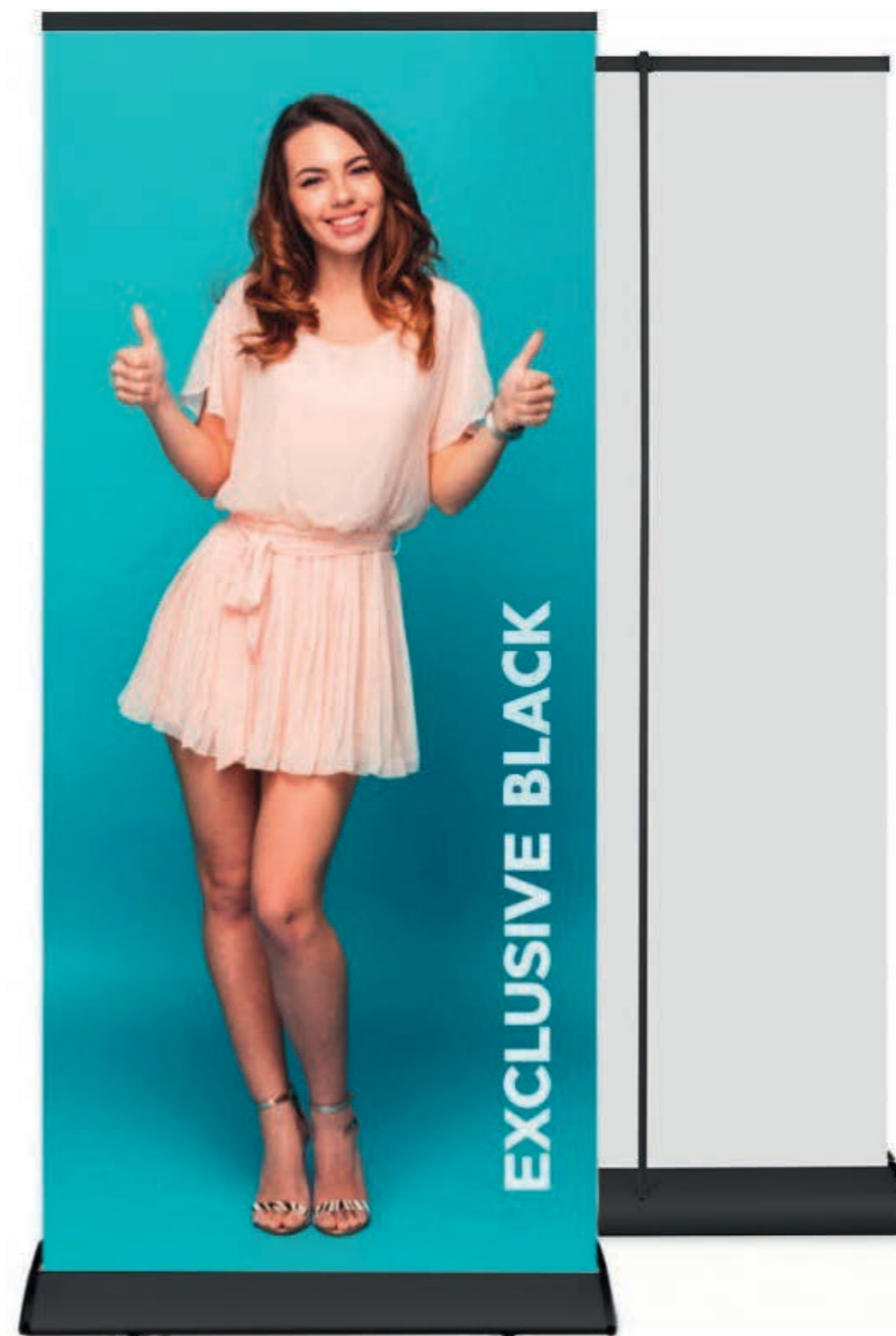
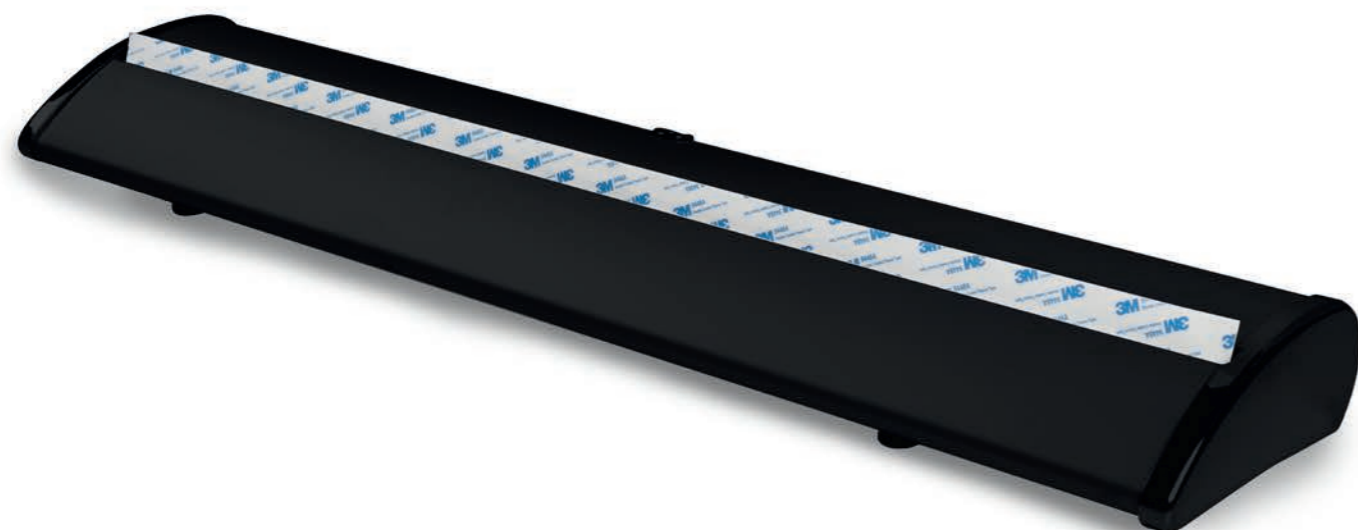

- elegant appearance
- 200×200 cm size available
- heavy and very stable product
- "Express Clip" top bar – quick and easy print assembly
- elegant carrying bag with a long zipper

This set includes: Exclusive Black roll up cassette, pole (sizes 120×200 and 150×200 include 2 poles, size 200×200 includes 3 poles), "Express Clip" top bar, 3M adhesive tape, bag with a business card pocket, individual box.

- elegantes Aussehen
- hohes Gewicht und Stabilität des Systems
- "Express Clip" obere Leiste – schnelle und einfache Druckmontage
- schicke Tasche mit langem Reisverschluss

Das Set enthält: Exclusive Black Roll-Up-Kassette, Mast, „Express Clip“ – obere Klemmleiste, 3M-Klebeband, Transporttasche mit Fenster für Visitenkarte, Einzelkarton.

- wyjątkowo elegancki wygląd
- bardzo ciężka, stabilna kasetka
- listwa „Express Clip” – błyskawiczny i łatwy montaż wydruku
- elegancka torba z długim zapięciem

Zestaw zawiera: kasetę typu Exclusive Black, maszt, listwę zatrzaskową „Express clip”, taśmę 3M, torbę transportową z okienkiem na wizytówkę, indywidualny karton.

85×200	5907451666982	2,7 kg
100×200	5907451666975	3,2 kg
120×200	5904423600692	3,8 kg
150×200	5904423600708	4,8 kg
200×200	5904423600715	6,4 kg

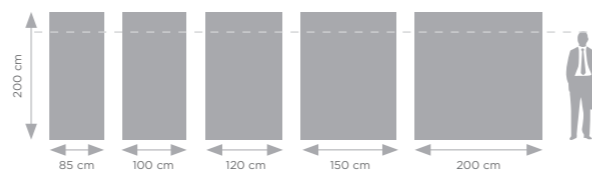

Recommended media and printing technology for this system:



EXCLUSIVE PLUS

NEW!

PREMIUM LINE

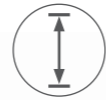

TELESCOPIC POLE



LONG ZIP BAG

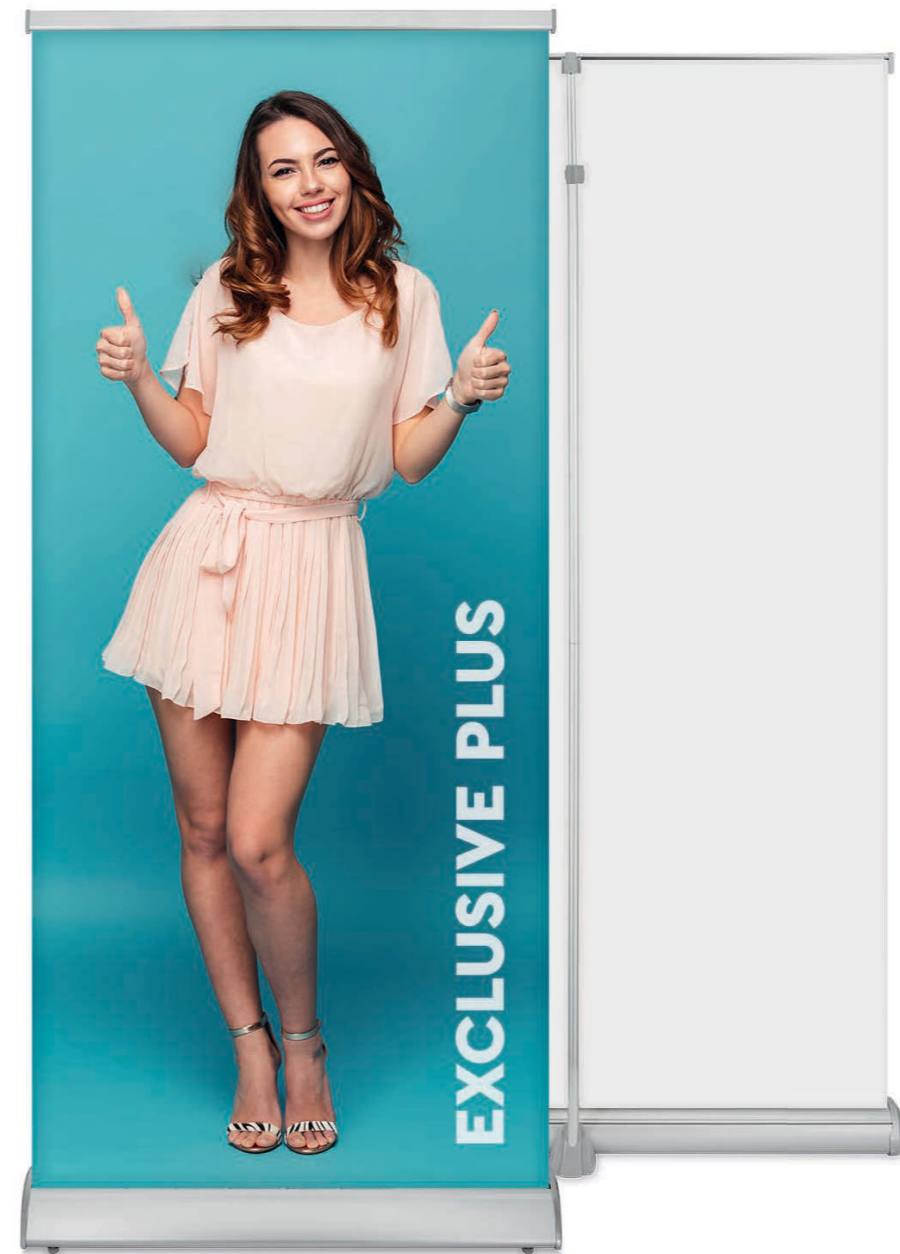
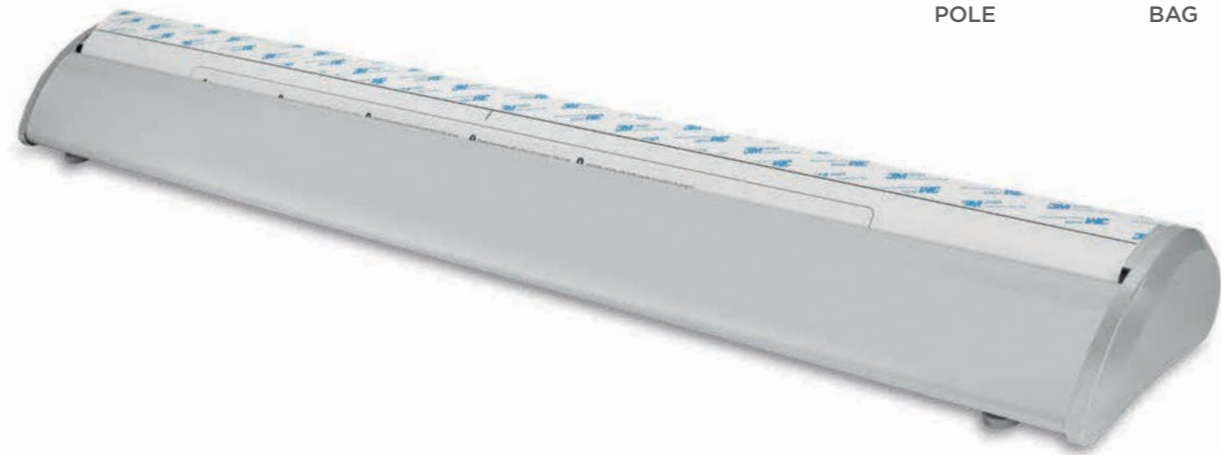

max 220 cm

- elegant appearance and unique design
- telescopic pole (up to 220 cm)
- exceptionally heavy, stable construction
- "Express Clip" top bar - very quick printout installation
- elegant carrying bag with a long zipper

The set contains: Exclusive Plus cassette, pole (sizes 120x220, 150x220 include 2 poles), "Express Clip" top bar, 3M adhesive tape, bag with a business card pocket, individual carton box.

- elegantes Erscheinungsbild und einzigartiges Design
- besonders schwere, stabile Konstruktion
- Teleskopmast (bis 220 cm)
- „Express Clip“-Leiste - blitzschnelle Druckmontage
- Tasche mit langem Reißverschluss

Das Set enthält: Roll-Up-Kassette Exclusive Plus, Mast (die Größen 120x200 und 150x200 haben zwei Masten), „Express Clip“-Leiste, 3M-Klebeband, Transporttasche, individuellen Karton.

- elegancki wygląd i unikalny design
- wyjątkowo ciężka, stabilna konstrukcja
- teleskopowy maszt (do 220 cm)
- listwa „Express Clip” - błyskawiczny montaż wydruku
- torba z długim zapięciem

Zestaw zawiera: kasety roll up Exclusive Plus, maszt (rozmiary 120x220, 150x220 zawierają 2 maszty), listwę zatrzaskową „Express Clip”, taśmę 3M, torbę transportową z okienkiem na wizytówkę, indywidualny karton.

85x220	5904423600753	4,2 kg
100x220	5904423600760	5,2 kg
120x220	5904423600777	6,9 kg
150x220	5904423600784	7,4 kg

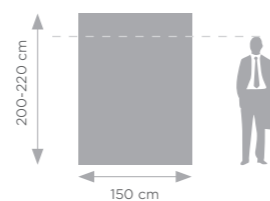
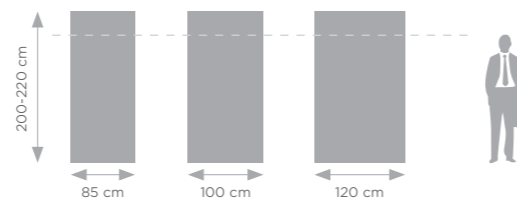

Recommended media and printing technology for this system:



WAVE

- 
GRAPHICS EXCHANGE SYSTEM
- 
TELESCOPIC POLE
- 
LONG ZIP BAG



- adjustable pole (up to 220 cm)
- graphics exchange system
- elegant, stylish look
- "Express Clip" top bar – quick and easy print assembly
- padded bag with a long zipper

This set includes: WAVE roll up cassette, pole (sizes 120×200 and 150×200 include 2 poles), "Express Clip" top bar, padded bag with a business card pocket, individual box.

- höhenverstellbar bis zu 220 cm
- Grafik-Austausch-System
- elegantes, außergewöhnliches Design
- "Express Clip" obere Leiste – schnelle und einfache Druckmontage
- gepolsterte, elegante Tasche mit langem Reißverschluss

Das Set enthält: WAVE Roll-Up-Kassette, Mast (die Größen 120×200 und 150×200 haben zwei Masten), „Express Clip“ – obere Klemmleiste, Transporttasche mit Fenster für Visitenkarte, Einzelkarton.

- regulowany maszt do 220 cm
- system wymiany grafiki
- elegancki, niecodzienny wygląd
- listwa „Express Clip” – błyskawiczny i łatwy montaż wydruku
- torba z długim zapięciem

Zestaw zawiera: kasetę typu WAVE, maszt (rozmiary 120×200 i 150×200 posiadają dwa maszty), listwę zatrzaskową „Express clip”, torbę transportową z okienkiem na wizytówkę, indywidualny karton.

		
85×200	5907451665831	2,6 kg
100×200	5907451665848	3,1 kg
120×200	5907451665855	3,7 kg
150×200	5907451665862	4,6 kg

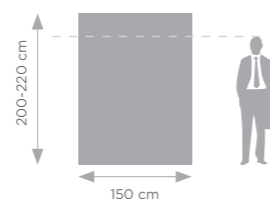
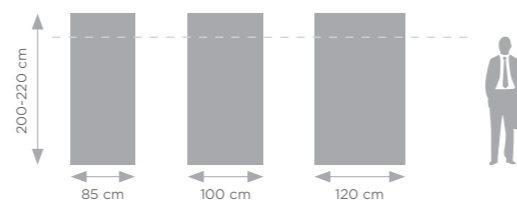

Recommended media and printing technology for this system:

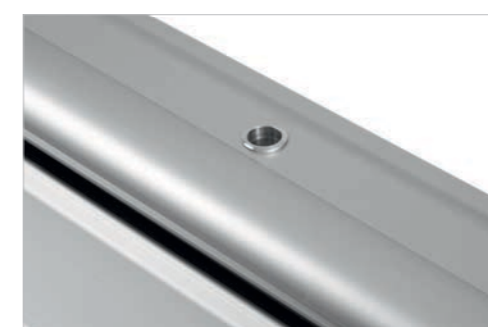

CLIP

NEW!

PREMIUM LINE



GRAPHICS EXCHANGE SYSTEM



TELESCOPIC POLE



LONG ZIP BAG



max 220 cm

- telescopic pole up to 220 cm
- graphics exchange system
- very stable construction
- "Express Clip" top bar - quick and easy print assembly
- inner pocket in the bag for mast and batten
- padded bag with a long zipper

The set includes: Clip roll up cassette, pole, "Express clip" top bar, transport bag with business card pocket, individual box.

- höhenverstellbarer Mast bis 220 cm
- Grafikwechselsystem
- besonders stabile Konstruktion
- "Express Clip" obere Leiste - schnelle und einfache Druckmontage
- Innentasche für Mast und Klemmleiste
- gepolsterte, elegante Tasche mit langem Reißverschluss

Das Set enthält: Roll-Up Clip, Mast, obere „Express Clip“-Klemmleiste, Transporttasche mit Fenster für Visitenkarte, Einzelkarton.

- teleskopowy maszt aż do 220 cm
- system wymiany grafiki
- bardzo stabilna konstrukcja
- listwa „Express Clip” - błyskawiczny i łatwy montaż wydruku
- torba z długim zapięciem
- wewnętrzna kieszeń w torbie na maszt i listwę

Zestaw zawiera: kasetę roll up Clip, maszt, listwę zatraskową „Express clip”, torbę transportową, indywidualny karton.

85x200	5907451668498	4 kg
100x200	5907451668504	4,3 kg

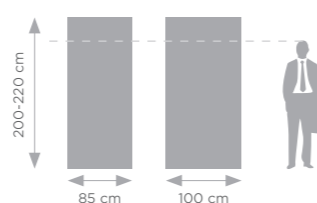

Recommended media and printing technology for this system:



TWIN



- two-sided roll up model: two separate printouts
- heavy and very stable product
- "Express Clip" top bar – quick and easy print assembly

This set includes: Twin roll up cassette, pole, "Express Clip" top bar, 3M adhesive tape, bag with a business card pocket, individual box.

- doppelseitiges Modell: hat zwei Ausdrücke
- hohes Gewicht und Stabilität des Systems
- "Express Clip" obere Leiste – schnelle und einfache Druckmontage

Das Set enthält: Twin Roll-Up-Kassette, Mast, „Express Clip“ – obere Klemmleiste, 3M-Klebeband, Transporttasche mit Fenster für Visitenkarte, Einzelkarton.

- model dwustronny – możliwość prezentacji dwóch różnych wydruków
- bardzo ciężka, stabilna kasetka
- listwa „Express Clip” – błyskawiczny i łatwy montaż wydruku

Zestaw zawiera: kasetę roll up Twin, maszt, listwę zatraskową „Express Clip”, taśmę 3M, torbę transportową z okienkiem na wizytówkę, indywidualny karton.

85x200	5907451660645	4 kg
100x200	5907451660652	4,7 kg

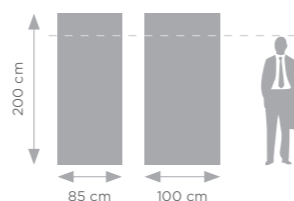

Recommended media and printing technology for this system:



ROLL UP ACCESSORIES

ROLL UP LIGHT

🇬🇧 If you need to illuminate the printout, our lamps, mounted directly on the roll-up pole, will be a perfect solution. Two variants are available: in LED and halogen technology. They will definitely improve the aesthetics of graphics.

🇩🇪 Wenn Sie den Druck beleuchten müssen, sind unsere Lampen, die direkt auf Roll up montiert sind, eine perfekte Lösung. Zwei Varianten stehen zur Verfügung: in LED - und Halogentechnik. Sie werden definitiv die Ästhetik von Grafiken verbessern.

🇵🇱 W przypadku konieczności oświetlenia wydruku, doskonale sprawdzą się nasze lampki, montowane bezpośrednio na maszcie roll up'ów. Dostępne są dwa warianty: w technologii LED i halogen. Zdecydowanie poprawią estetykę i odbiór grafiki.

HALOGEN



5907451669945 0,3 kg

LED

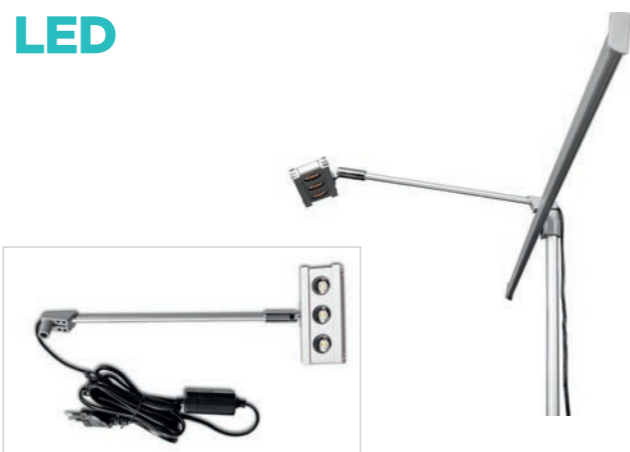

5907451669938 0,3 kg

BLOCKOUTS



- high class materials
- materials do not let light through
- opaque surface prevents unwanted reflexes
- high density and thickness

- hochwertige Materialien
- Materialien lassen kein Licht durch
- undurchsichtige Oberfläche verhindert unerwünschte Reflexe
- hohe Dichte und Dicke

- wysoka jakość
- materiał nie przepuszcza światła
- matowa powierzchnia zapobiega pojawianiu się niechcianych refleksów
- wysoka gramatura

	Width (m)	Barcode
Standard 330 g	0,914	5907451668610
Standard 330 g	1,07	5907451669402
Standard 330 g	1,27	5907451668528
Standard 330 g	1,52	5907451667194
Premium 330 g	0,914	5907451663219
Premium 330 g	1,07	5907451663226
Premium 330 g	1,27	5907451663233
Premium 330 g	1,52	5907451663240
Premium B1 FR (flame retardant) 330 g	0,914	5907451667316
Premium B1 FR (flame retardant) 330 g	1,07	5907451667323
Premium B1 FR (flame retardant) 330 g	1,27	5907451667293
PVC Free 260 g	0,914	5907451663257
PVC Free 260 g	1,07	5907451667309



STANDS

X-BANNER COMPACT

- low cost system
- simple handling
- ultralight construction made of fiberglass

This set includes: complete X-banner system and a simple bag.

- ein billiges System
- einfache Bedienung
- ultraleichte Fiberglaskonstruktion

Das Set enthält: ein komplettes X-Banner-System, eine einfache Tasche.

- bardzo niski koszt systemu
- prosty sposób obsługi
- ultralekka konstrukcja wykonana z włókna szklanego

Zestaw zawiera: system X-banner, prostą torbę transportową.

60x160	5907451660195	0,6 kg
80x180	5907451660201	0,8 kg

Recommended media and printing technology for this system:

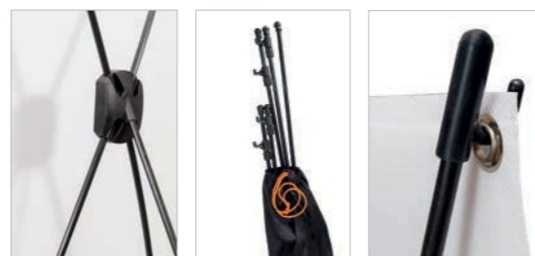
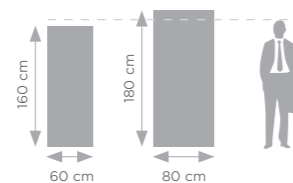

X-BANNER STANDARD

- improved model of X-banner system
- construction made of metal painted in black and fiberglass
- high quality
- ultralight, easy to carry and use

This set includes: complete X-banner system and a bag (the print-out also can fit in).

- höheres X-Banner-Systemmodell
- schwarze pulverbeschichtete Metall und Fiberglaskonstruktion
- hochwertige Verarbeitung
- ultra-leicht und einfach zu bedienen

Das Set enthält: ein komplettes X-Banner-System, eine Tasche, in die auch ein Ausdruck past.

- ulepszona wersja systemu X-banner
- konstrukcja wykonana z metalu malowanego na czarno oraz włókna szklanego
- wysoka jakość
- ultralekka konstrukcja łatwa do przenoszenia i użytku

Zestaw zawiera: system X-banner, torbę transportową, w którą zmieści się również wydruk.

60x160	5907451660218	1,3 kg
80x180	5907451660225	1,4 kg
120x210	5907451660232	1,7 kg

Recommended media and printing technology for this system:

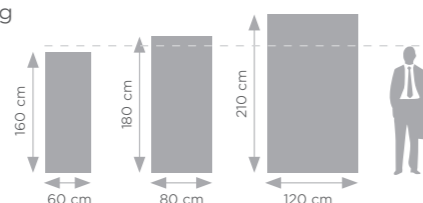

L-BANNER

- low cost system
- simple handling
- ultralight
- single and double sided version available

These sets include: complete L-banner system and a simple bag (the printout also can fit in).

- ein billiges System
- ultraleicht
- einfach zu bedienen
- einzel und doppelseitige Version erhältlich

Das Set enthält: ein komplettes L-Banner-System, eine Tasche, in die auch ein Ausdruck past.

- bardzo niski koszt systemu
- prosty sposób obsługi
- ultralekki
- w ofercie wersja jedno i dwustronna

Zestawy zawierają: system L-banner, prostą torbę transportową, w którą zmieści się również wydruk.

Recommended media and printing technology for this systems:



L-BANNER PREMIUM



85x210	5907451660669	1,4 kg

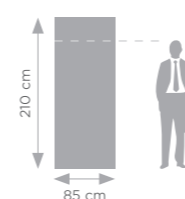

L-BANNER PREMIUM TWIN



85x210	5907451660683	2,40 kg
100x210	5907451660690	2,70 kg

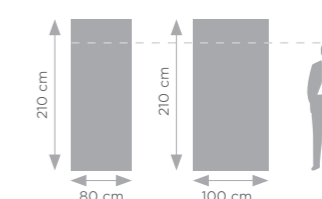

ATLANTIS EXPO

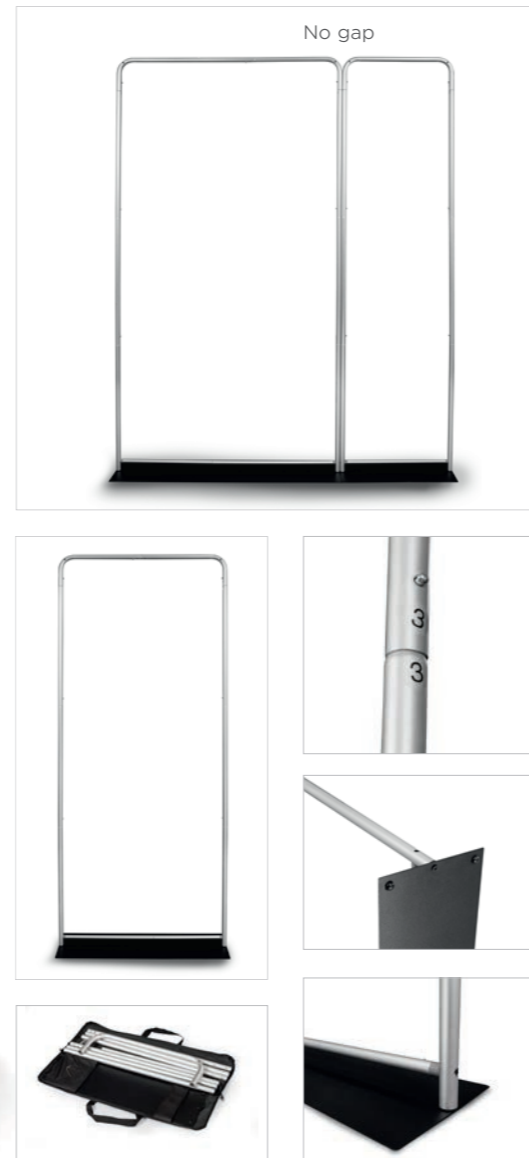

- base made of metal plate
- **very stable construction (profile - Ø 25 mm)**
- value for money
- simple handling
- double-sided system

This set includes: complete Expo system and a bag (the printout also can fit in).

- Metallplatte Basis
- **sehr stabile Konstruktion (Profilbreite - Ø 25 mm)**
- sehr niedrige Systemkosten
- einfache Bedienung
- doppelseitig

Das Set enthält: ein komplettes Expo System, eine Tasche, in die auch ein Ausdruck past.

- podstawa wykonana z metalowej płyty
- **bardzo stabilna konstrukcja (profil - Ø 25 mm)**
- niski koszt systemu
- prosty sposób obsługi
- system dwustronny

Zestaw zawiera: system Expo, torbę transportową, w którą zmieści się również wydruk.

60x230	5907451660409	4,30 kg
90x230	5907451660416	5,60 kg
120x230	5907451660423	8,00 kg
150x230	5907451660430	9,70 kg

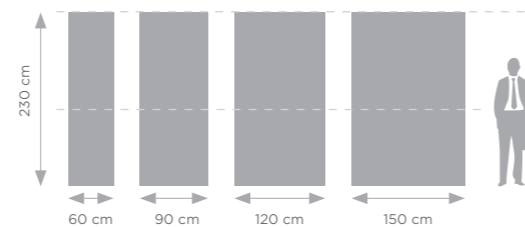

Recommended media and printing technology for this system:



ADVERTISING WALLS

MEGA SEG™ SYSTEM

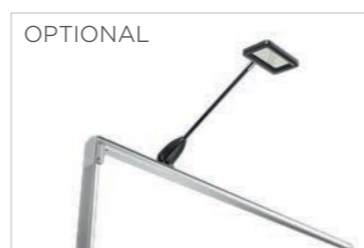
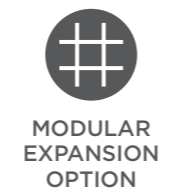

MEGA SEG SYSTEMS ARE DISTINGUISHED BY ITS PRE-ASSEMBLED DESIGN, WHICH SIMPLY NEEDS TO BE OPENED.

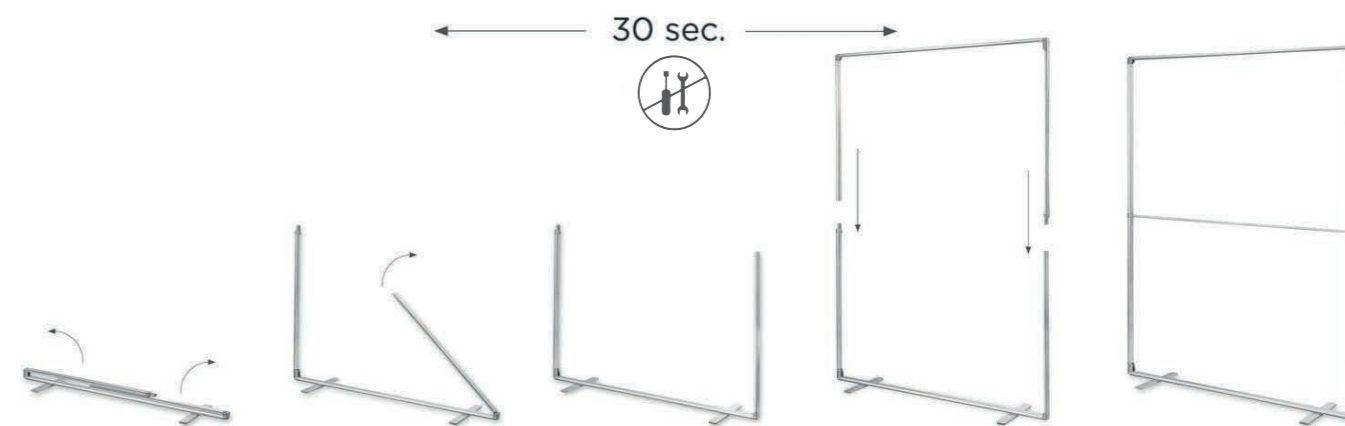

MEGA SEG SYSTEMS CAN BE CONNECTED TOGETHER USING SPECIAL CONNECTORS. THIS OFFERS ALMOST UNLIMITED POSSIBILITIES OF CREATING DIFFERENT SYSTEMS. CONNECTING THE PRODUCTS IN PARALLEL ALLOWS A SINGLE PRINT TO BE APPLIED, WITH NO VISIBLE GAPS BETWEEN THE SYSTEMS.



- ultralight, double-sided, modular system
 - **flex system - faster and easier assembly thanks to its hinge-based construction**
 - aluminium profile - 4,2 cm
 - no tools assembly
 - graphics mounted with silicone tape
 - **several walls - one printout!**
- The set includes: MEGA SEG system, a set of connectors (parallel - 4 pieces, top - 1 piece, bottom - 1 piece), transport bag.

- ultraleichtes, doppelseitiges, modulares System
 - **Flex-System - schnellere und einfachere Montage dank einer auf Scharnieren basierenden Konstruktion**
 - Rahmenbreite - 4,2 cm
 - Montage ohne Werkzeug
 - Silikonband montiert Ausdruck
 - **mehrere Wände - ein Druck!**
- Das Set enthält: MEGA SEG-System, Verbindungssatz (Serie - 4 Stück, oben - 1 Stück, unten - 1 Stück), Transporttasche.

- ultralekki, dwustronny, modułowy system
 - **system flex - szybszy i łatwiejszy montaż dzięki konstrukcji opartej na zawiasach**
 - profil aluminiowy - 4,2 cm
 - montaż bez narzędzi
 - grafika montowana za pomocą taśmy silikonowej
 - **kilka ścianek = 1 wydruk!**
- Zestaw zawiera: system MEGA SEG, zestaw konektorów (szeregowe - 4 szt., górny - 1 szt., dolny - 1 szt.), torbę transportową.

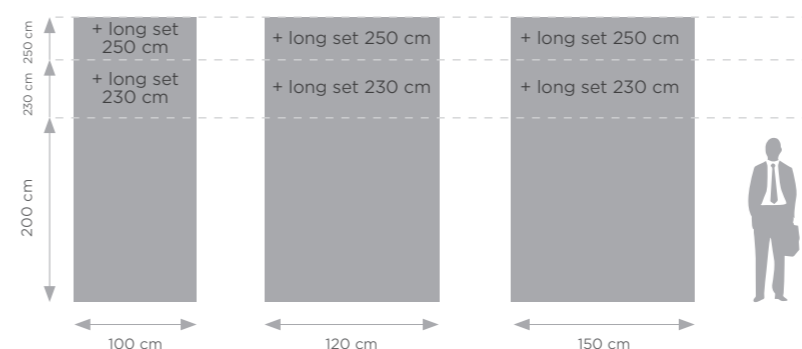

The Long Sets increase the height of the product up to 230 or 250 cm.

100x200	5907451668948	2,1 kg
120x200	5907451668931	2,6 kg
150x200	5907451668924	3,2 kg

Recommended media and printing technology for this system:

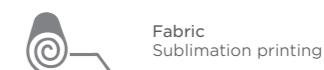

POP-UP STRAIGHT



- the best value for money
- “pop up” mechanism - express unfolding
- interchangeable briches

This set includes: Pop-up frame, set of construction bars, set of upper 3M magnetic bars, 3M magnetic tape, set of PVC boards.

- das beste Preis-Leistungs-Verhältnis
- „Pop-Up“-Mechanismus - sofortiges Falten der Wand
- austauschbaren Lamellen

Das Set enthält: Pop-up Wand, ein Satz Konstruktions Bügeln, ein Satz 3M Befestigungsstreifen für Paneelen Montage, 3M magnetische Band, ein Satz Paneele.

- dobry stosunek ceny do jakości
- mechizm „pop up” - błyskawiczne rozłożenie systemu
- wymienialne bryty

Zestaw zawiera: stelaż Pop-up, komplet listew konstrukcyjnych, komplet listew samoklejących 3M górnych do montażu brytów, taśmę magnetyczną 3M, komplet brytów do grafiki.

3x3 (in trolley case)	5907451660317	24 kg
3x3 (in counter case)	5907451666081	24 kg
3x4 (in trolley case)	5907451660324	28 kg
3x4 (in counter case)	5907451666098	28 kg

Case counter and trolley bag - page 84

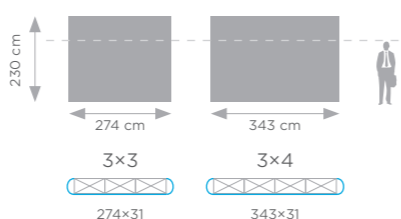

Recommended media and printing technology for this system:



POP-UP ARC

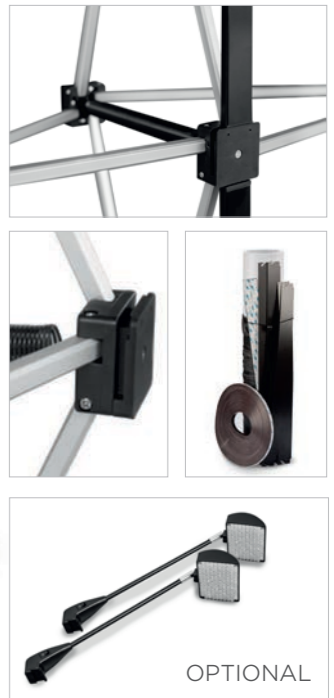

- the best value for money
- “pop up” mechanism - express unfolding
- interchangeable briches

This set includes: Pop-up frame, set of construction bars, set of upper 3M magnetic bars, 3M magnetic tape, set of PVC boards.

- das beste Preis-Leistungs-Verhältnis
- „Pop-Up“-Mechanismus - sofortiges Falten der Wand
- austauschbaren Lamellen

Das Set enthält: Pop-up Wand, ein Satz Konstruktions Bügeln, ein Satz 3M Befestigungsstreifen für Paneelen Montage, 3M magnetische Band, ein Satz Paneele.

- dobry stosunek ceny do jakości
- mechizm „pop up” - błyskawiczne rozłożenie systemu
- wymienialne bryty

Zestaw zawiera: stelaż Pop-up, komplet listew konstrukcyjnych, komplet listew samoklejących 3M górnych do montażu brytów, taśmę magnetyczną 3M, komplet brytów do grafiki.

3x3 (in trolley case)	5907451660331	24 kg
3x3 (in counter case)	5907451666104	24 kg
3x4 (in trolley case)	5907451660348	28 kg
3x4 (in counter case)	5907451666111	28 kg

Case counter and trolley bag - page 84

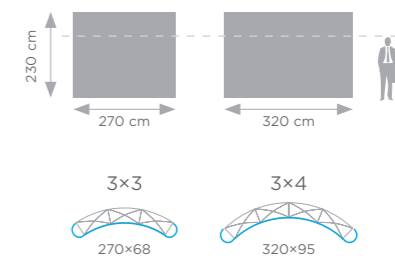

Recommended media and printing technology for this system:



STANDARD MAGNETIC POP-UP STRAIGHT



- special system of fast assembling element using built-in magnets
- "pop up" mechanism - express unfolding
- interchangeable briches

This set includes: Standard Magnetic Pop-up frame, set of magnetic construction bars, set of upper 3M magnetic bars, 3M magnetic tape, set of PVC boards.

- Schnellkupplungssystem von Komponenten mit integrierten Magneten
- „Pop-Up“-Mechanismus - sofortiges Falten der Wand
- austauschbaren Lamellen

Das Set enthält: Standard Magnetic Pop-up Wand, ein Satz Konstruktions Bügeln (magnetisch), ein Satz 3M Befestigungsstreifen für Paneelen Montage, 3M magnetische Band, ein Satz Paneele.

- system szybkiego łączenia elementów za pomocą wbudowanych magnesów
- system „pop up“ - błyskawiczny montaż i demontaż
- wymienne bryty

Zestaw zawiera: stelaż Standard Magnetic Pop-up, komplet magnetycznych listew konstrukcyjnych, komplet listew samoklejących 3M górnych do montażu brytów, taśmę magnetyczną 3M, komplet brytów do grafiki.

3x3 (in trolley case)	5907451661024	22 kg
3x3 (in case counter)	5907451665985	22 kg
3x4 (in trolley case)	5907451661031	26 kg

Case counter and trolley bag - page 84

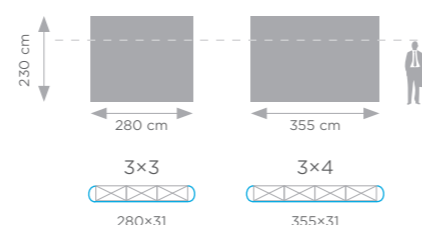

Recommended media and printing technology for this system:



STANDARD MAGNETIC POP-UP ARC



- special system of fast assembling element using built-in magnets
- "pop up" mechanism - express unfolding
- interchangeable briches

This set includes: Standard Magnetic Pop-up frame, set of magnetic construction bars, set of upper 3M magnetic bars, 3M magnetic tape, set of PVC boards.

- Schnellkupplungssystem von Komponenten mit integrierten Magneten
- „Pop-Up“-Mechanismus - sofortiges Falten der Wand
- austauschbaren Lamellen

Das Set enthält: Standard Magnetic Pop-up Wand, ein Satz Konstruktions Bügeln (magnetisch), ein Satz 3M Befestigungsstreifen für Paneelen Montage, 3M magnetische Band, ein Satz Paneele.

- system szybkiego łączenia elementów za pomocą wbudowanych magnesów
- system „pop up“ - błyskawiczny montaż i demontaż
- wymienne bryty

Zestaw zawiera: stelaż Standard Magnetic Pop-up, komplet magnetycznych listew konstrukcyjnych, komplet listew samoklejących 3M górnych do montażu brytów, taśmę magnetyczną 3M, komplet brytów do grafiki.

3x3 (in trolley case)	5907451660959	22 kg
3x3 (in case counter)	5907451665961	22 kg
3x4 (in trolley case)	5907451660966	26 kg
3x4 (in case counter)	5907451665978	26 kg

Case counter and trolley bag - page 84

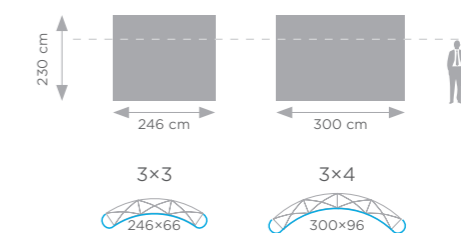

Recommended media and printing technology for this system:



PREMIUM MAGNETIC POP-UP STRAIGHT

PREMIUM LINE



- high quality of construction
- "pop up" mechanism - express unfolding
- magnetic installation system
- interchangeable briches
- case counter

The set includes: Premium Magnetic Pop-up frame, top bars with adhesive tape for mounting PVC panels, a set of construction bars, a set of PVC panels, case counter.

- hohe Verarbeitungsqualität
- „Pop-Up“-Mechanismus - sofortiges Falten der Wand
- magnetisches Verbindungssystem
- austauschbaren Lamellen
- Koffertheke

Das Set enthält: Premium Magnetic Pop-up Wand, Befestigungsstreifen für die Lamellen mit Klebeband, einen Satz Konstruktionsstreifen, einen Satz Lamellen, eine Koffertheke.

- bardzo wysoka jakość wykonania
- system „pop up“ - błyskawiczne rozłożenie ścianki
- magnetyczny montaż listew konstrukcyjnych i brytów
- wymienne bryty
- ambona w zestawie

Zestaw zawiera: stelaż Premium Magnetic Pop-up, listwy mocujące bryty, komplet listew konstrukcyjnych, komplet brytów, ambonę na kółkach.

3x3	5907451666364	27 kg
3x4	5907451666371	31 kg

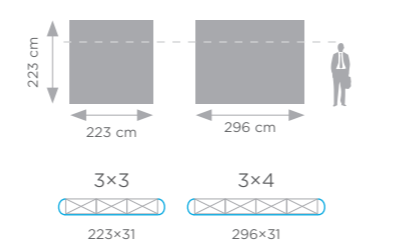

Recommended media and printing technology for this system:



PREMIUM MAGNETIC POP-UP ARC

PREMIUM LINE

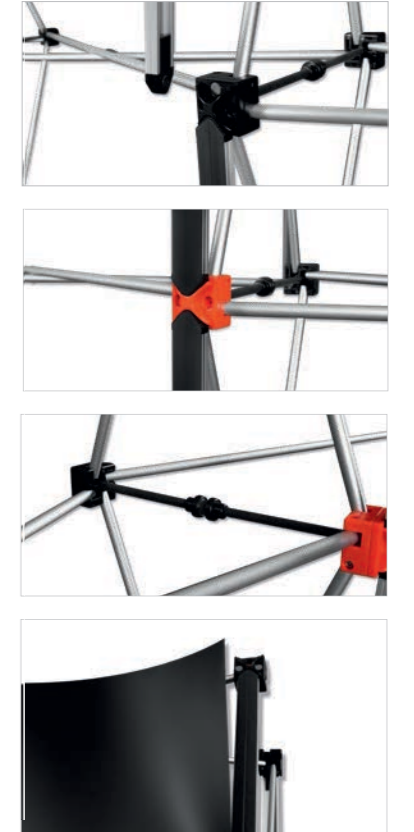
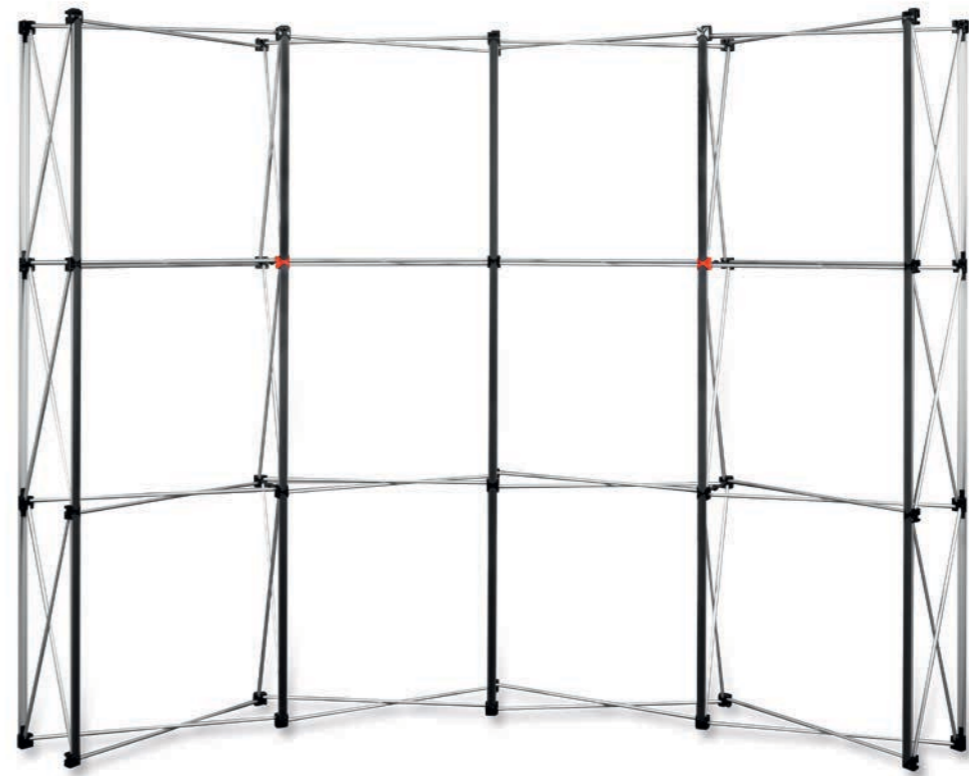

- high quality of construction
- "pop up" mechanism - express unfolding
- magnetic installation system
- interchangeable briches
- case counter

The set includes: Premium Magnetic Pop-up frame, top bars with adhesive tape for mounting PVC panels, a set of construction bars, a set of PVC panels, case counter.

- hohe Verarbeitungsqualität
- „Pop-Up“-Mechanismus - sofortiges Falten der Wand
- magnetisches Verbindungssystem
- austauschbaren Lamellen
- Koffertheke

Das Set enthält: Premium Magnetic Pop-up Wand, Befestigungsstreifen für die Lamellen mit Klebeband, einen Satz Konstruktionsstreifen, einen Satz Lamellen, eine Koffertheke.

- bardzo wysoka jakość wykonania
- system „pop up“ - błyskawiczne rozłożenie ścianki
- magnetyczny montaż listew konstrukcyjnych i brytów
- wymienne bryty
- ambona w zestawie

Zestaw zawiera: stelaż Premium Magnetic Pop-up, listwy mocujące bryty, komplet listew konstrukcyjnych, komplet brytów, ambonę na kółkach.

3x3	5907451666388	27 kg
3x4	5907451666395	31 kg

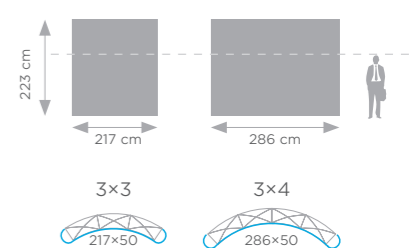

Recommended media and printing technology for this system:



BLACK PRO MAGNETIC POP-UP STRAIGHT

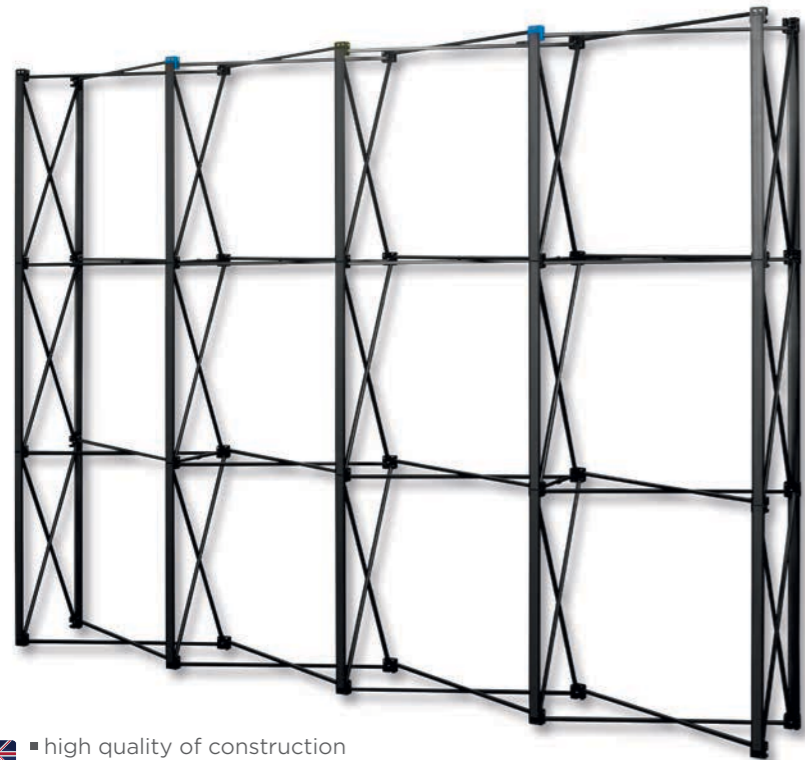

- high quality of construction
- "pop up" mechanism - express unfolding
- magnetic installation system
- interchangeable bristles
- case counter

The set includes: Black Pro Magnetic Pop-up frame, top bars with 3M adhesive tape for mounting PVC panels, a set of construction bars, a set of PVC panels, case counter.

- hohe Verarbeitungsqualität
- „Pop-Up“-Mechanismus - sofortiges Falten der Wand
- magnetisches Verbindungssystem
- austauschbaren Lamellen
- Koffertheke

Das Set enthält: Black Pro Magnetic Pop-up Wand, Befestigungsstreifen für die Lamellen mit Klebeband, einen Satz Konstruktionsstreifen, einen Satz Lamellen, eine Koffertheke.

- bardzo wysoka jakość wykonania
- podwójne magnesy
- system „pop up“ - błyskawiczne rozłożenie ścianki
- magnetyczny montaż listew konstrukcyjnych i brytów
- wymienne bryty
- ambona w zestawie

Zestaw zawiera: stelaż Black Pro Magnetic Pop-up, listwy mocujące bryty, komplet listew konstrukcyjnych, komplet brytów, ambonę na kółkach.

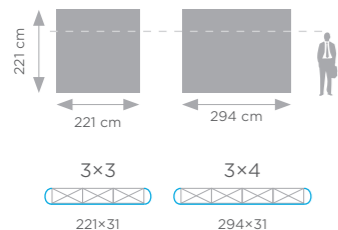

3x3	5907451666319	31 kg
3x4	5907451666326	34 kg

Recommended media and printing technology for this system:



Foil Solvent, UV, Latex

OPTIONAL

BLACK PRO MAGNETIC POP-UP ARC

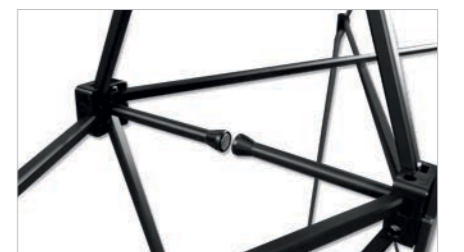
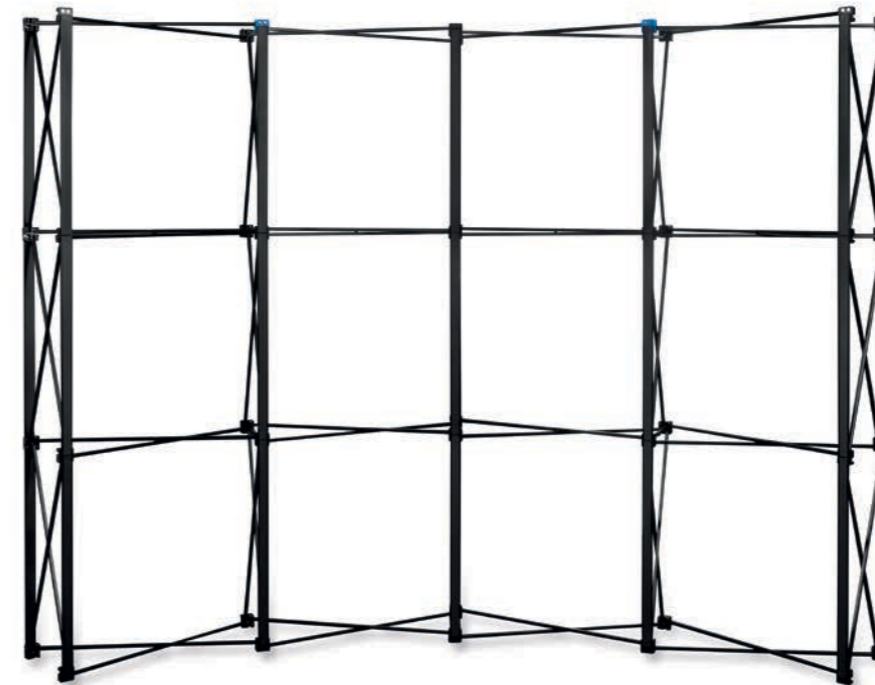

- high quality of construction
- "pop up" mechanism - express unfolding
- magnetic installation system
- interchangeable bristles
- case counter

The set includes: Black Pro Magnetic Pop-up frame, top bars with 3M adhesive tape for mounting PVC panels, a set of construction bars, a set of PVC panels, case counter.

- hohe Verarbeitungsqualität
- „Pop-Up“-Mechanismus - sofortiges Falten der Wand
- magnetisches Verbindungssystem
- austauschbaren Lamellen
- Koffertheke

Das Set enthält: Black Pro Magnetic Pop-up Wand, Befestigungsstreifen für die Lamellen mit Klebeband, einen Satz Konstruktionsstreifen, einen Satz Lamellen, eine Koffertheke.

- bardzo wysoka jakość wykonania
- podwójne magnesy
- system „pop up“ - błyskawiczne rozłożenie ścianki
- magnetyczny montaż listew konstrukcyjnych i brytów
- wymienne bryty
- ambona w zestawie

Zestaw zawiera: stelaż Black Pro Magnetic Pop-up, listwy mocujące bryty, komplet listew konstrukcyjnych, komplet brytów, ambonę na kółkach.

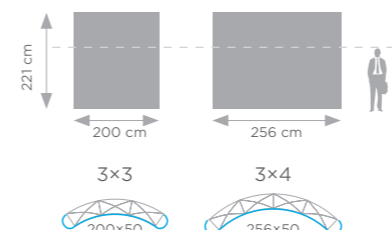

3x3	5907451666333	31 kg
3x4	5907451666340	34 kg

Recommended media and printing technology for this system:



Foil Solvent, UV, Latex

OPTIONAL

VELCRO POP-UP STRAIGHT



- wall designed for mounting textile graphics on it, using Velcro tape
- one piece graphics without PVC boards
- "pop up" mechanism - express unfolding

This set includes: Velcro Pop-up frame, Velcro tape, Canvas bag.

- die Wand ist für die Montage von Textilgrafiken ohne den Einsatz von Paneelen konzipiert
- „Pop-Up“-Mechanismus - sofortiges Falten der Wand
- Ausdruck in einem Stück, ohne Paneelen

Das Set enthält: Velcro Pop-up Wand, Klettband, Canvas Tasche.

- ścianka przeznaczona do montażu grafik tekstylnych bez użycia brytów
- grafika w jednej części, bez podziału na bryty
- mechanizm „pop up” - błyskawiczne rozłożenie systemu

Zestaw zawiera: stelaż Velcro Pop-up, taśmę rzep do wszycia w grafikę, torbę typu Canvas.

3x3	5907451660973	8,5 kg
3x4	5907451660980	10 kg

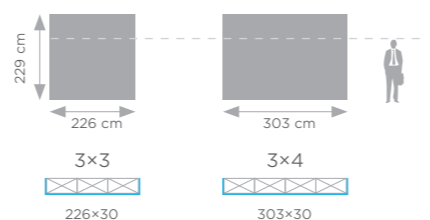

Recommended media and printing technology for this system:



VELCRO POP-UP ARC



- wall designed for mounting textile graphics on it, using Velcro tape
- one piece graphics without PVC boards
- "pop up" mechanism - express unfolding

This set includes: Velcro Pop-up frame, Velcro tape, Canvas bag.

- die Wand ist für die Montage von Textilgrafiken ohne den Einsatz von Paneelen konzipiert
- „Pop-Up“-Mechanismus - sofortiges Falten der Wand
- Ausdruck in einem Stück, ohne Paneelen

Das Set enthält: Velcro Pop-up Wand, Klettband, Canvas Tasche.

- ścianka przeznaczona do montażu grafik tekstylnych bez użycia brytów
- grafika w jednej części, bez podziału na bryty
- mechanizm „pop up” - błyskawiczne rozłożenie systemu

Zestaw zawiera: stelaż Velcro Pop-up, taśmę rzep do wszycia w grafikę, torbę typu Canvas.

3x3	5907451660997	8,5 kg
3x4	5907451661000	10 kg

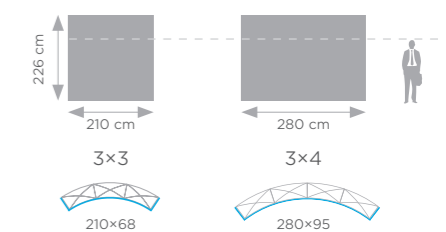

Recommended media and printing technology for this system:



ATLANTIS STRAIGHT



- lightweight, small construction, large graphic presentation surface
- double sided graphic pulled on frame on principle of putting on a sock
- quick assembly
- value for money

This set includes: Atlantis frame and a Canvas bag.

- kleine und leichte Konstruktion, grose Grafikfläche
- doppelseitige Grafiken nach dem Prinzip „Dehnen der Socke“
- schnelle Installation
- Preis-Leistungsverhältnis

Das Set enthält: Wand Atlantis, Canvas Tasche.

- mała i lekka konstrukcja
- duża powierzchnia prezentacji grafiki
- dwustronna grafika zakładana na zasadzie „naciągania skarpety“
- szybki montaż
- dobry stosunek jakości do ceny

Zestaw zawiera: stelaż Atlantis, torbę transportową typu Canvas.

Size	Barcode	Weight
250x230	5907451661109	7 kg
300x230	5907451661116	8 kg
400x230	5907451661123	9 kg
590x230	5907451663769	15 kg

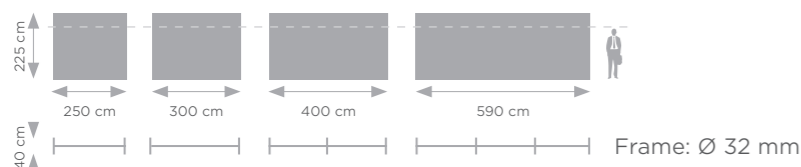

Recommended media and printing technology for this system:



OPTIONAL

ATLANTIS ARC



- thanks to the curved sides, part of the graphics is also visible from the side.
- lightweight, small construction, large graphic presentation surface
- double sided graphic pulled on frame on principle of putting on a sock
- quick assembly
- value for money

This set includes: Atlantis frame and a Canvas bag.

- mit gekrümmten Seiten ist ein Teil der Grafik seitlich sichtbar
- kleine und leichte Konstruktion, grose Grafikfläche
- doppelseitige Grafiken nach dem Prinzip „Dehnen der Socke“
- schnelle Installation
- Preis-Leistungsverhältnis

Das Set enthält: Wand Atlantis, Canvas Tasche.

- mała i lekka konstrukcja
- duża powierzchnia prezentacji grafiki
- dwustronna grafika zakładana na zasadzie „naciągania skarpety“
- szybki montaż
- dobry stosunek jakości do ceny

Zestaw zawiera: stelaż Atlantis, torbę transportową typu Canvas.

Size	Barcode	Weight
250x230	5907451661154	5 kg
300x230	5907451661161	6 kg
400x230	5907451661178	7 kg
530x230	5907451661185	10 kg

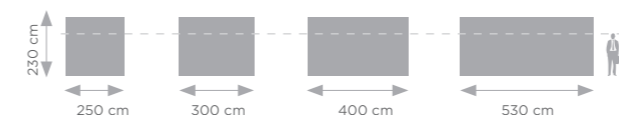

Recommended media and printing technology for this system:

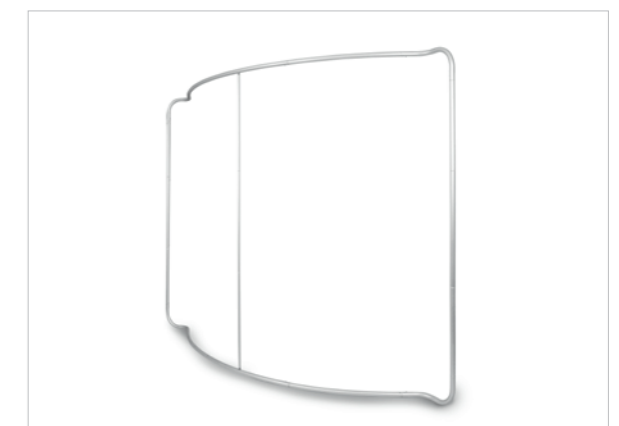

OPTIONAL

ATLANTIS S-SHAPE



- very impressive version of the Atlantis wall
- lightweight, small construction, large graphic presentation surface
- double sided graphic pulled on frame on principle of putting on a sock
- quick assembly
- value for money

This set includes: Atlantis frame, Canvas bag.

- die glamouröseste Version unter den Wänden von Atlantis
- kleine und leichte Konstruktion, große Grafikfläche
- doppelseitige Grafiken nach dem Prinzip „Dehnen der Socke“
- schnelle Installation
- Preis-Leistungsverhältnis

Das Set enthält: Wand Atlantis, Canvas Tasche.

- mała i lekka konstrukcja
- duża powierzchnia prezentacji grafiki
- dwustronna grafika zakładana na zasadzie „naciągania skarpety“
- szybki montaż
- dobry stosunek jakości do ceny

Zestaw zawiera: stelaż Atlantis, torbę transportową typu Canvas.

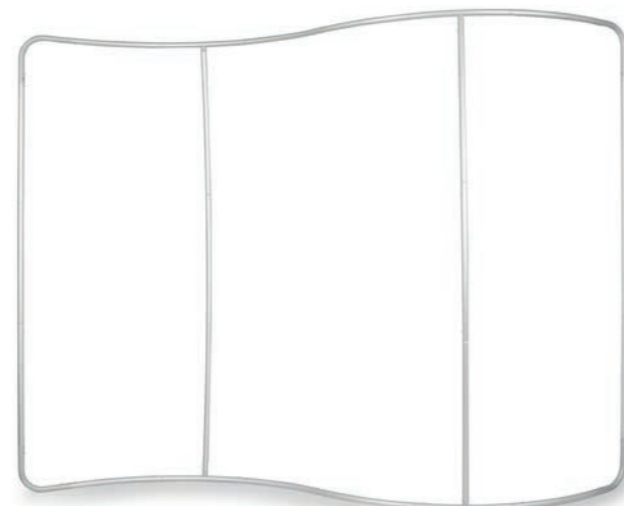

Frame: Ø 32 mm



OPTIONAL

Recommended media and printing technology for this system:

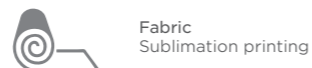

Fabric Sublimation printing

Size	Barcode	Weight
250x230	5907451663097	5 kg
300x230	5907451661192	6 kg
400x230	5907451661208	7 kg
500x230	5907451661215	9 kg
650x230	5907451661222	11 kg

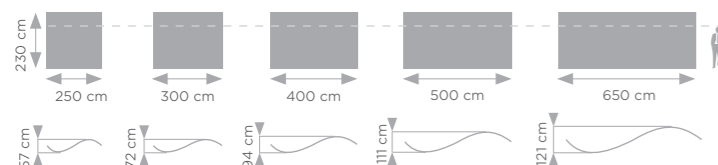

ATLANTIS U-SHAPE



- graphic pulled on frame on principle of putting on a sock
- extra legs make the system very stable

This set includes: Atlantis frame and a Canvas bag.

- doppelseitige Grafiken nach dem Prinzip „Dehnen der Socke“
- stabilisierende Füße enthalten

Das Set enthält: Wand Atlantis, Canvas Tasche.

- grafika zakładana na zasadzie „naciągania skarpety“
- stabilna konstrukcja dzięki dodatkowym nogom

Zestaw zawiera: stelaż Atlantis, torbę typu Canvas.

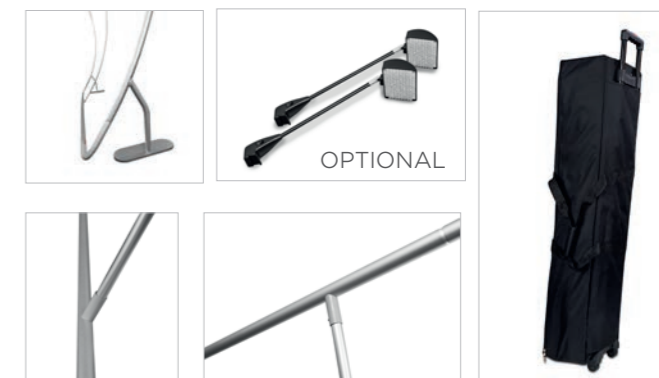

OPTIONAL

Size	Barcode	Weight
250x230	5907451669884	5 kg
300x230	5907451661239	6 kg

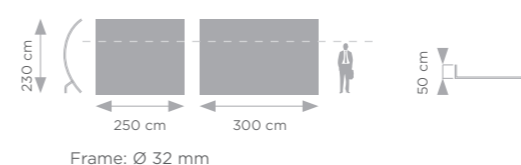

Frame: Ø 32 mm

Recommended media and printing technology for this system:



Fabric Sublimation printing

COMBI SYSTEMS

 Shelving system for Atlantis (straight) walls. Thanks to this simple solution, each wall can become a complete, independent and very functional exhibition system. Perfect for promotional, educational and fair stands. The system has 3 horizontal black shelves made of thick plastic imitating wood, or 3 pockets for catalogs and leaflets, made of thick plexiglass. In the upper part of the system, there is a board on which a company logo or other graphics can be printed (foil).

 Regalsystem für Atlantis (gerade) Wände. Dank dieser einfachen Lösung kann jede Wand zu einem kompletten, unabhängigen und sehr funktionalen Ausstellungssystem werden. Perfekt für Werbe-, Bildungs- und Messestände. Das System verfügt über 3 horizontale schwarze Regale aus dickem Kunststoff, der Holz nachahmt, oder über 3 Taschen für Kataloge und Prospekte aus dickem Plexiglas. Im oberen Teil des Systems befindet sich eine Tafel, auf der ein Firmenlogo oder andere Grafiken (Folie) gedruckt werden können.

 System półek przeznaczony do ścianek Atlantis (prostych). Dzięki temu prostemu rozwiązaniu, każda ścianka może stać się kompletnym, niezależnym i bardzo funkcjonalnym systemem targowym. Doskonale sprawdzi się na stoiskach promocyjnych, edukacyjnych i targowych. System posiada 3 półki poziome w kolorze czarnym, wykonane z grubego tworzywa sztucznego imitującego drewno lub 3 kieszenie na katalogi i ulotki, wykonane z grubego tworzywa pleksi. W górnej części systemu znajduje się tablica, na której można wykonać wydruk (folia) firmowego logo lub innej grafiki.

COMBI 1



COMBI 2



The set contains the COMBI system only. The Atlantis wall must be purchased separately.

		
Combi 1	5907451665039	12 kg
Combi 2	5907451665022	8 kg

VERSUM

 walls intended for big size frontlit banner graphics
 value for money
 adjustable frame, which can obtain various sizes
 stable construction

These sets include: Versum frame and a transport bag.

 wände für Banner-Grafiken mit großen Oberflächen
 Preis-Leistungsverhältnis
 verstellbarer Rahmen, der verschiedene Größen erhalten kann
 stabile Konstruktion

Das Set enthält: Versum Wandrahmen, Transporttasche.

 ścianki przeznaczone do grafik banerowych o dużych powierzchniach
 dobry stosunek jakości do ceny
 regulowana rama, która pozwala uzyskać różne rozmiary
 stabilna konstrukcja

Zestawy zawierają: stelaż Versum, torbę transportową.

Recommended media and printing technology for this system:



VERSUM

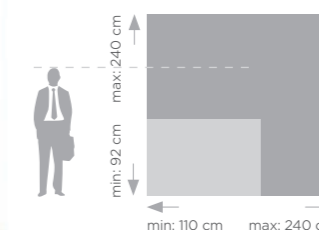
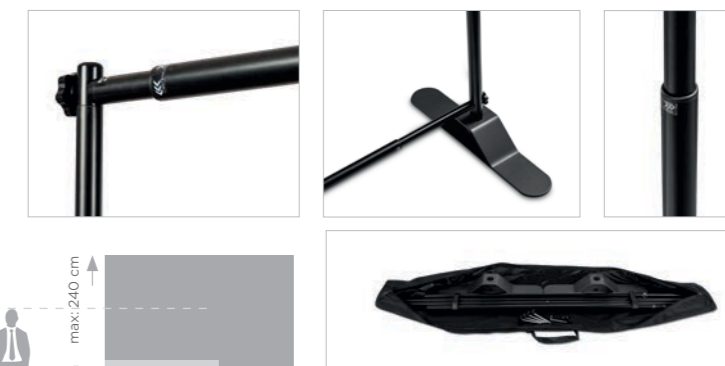

	
5907451661086	5,8 kg

Frame: Ø 22 mm

VERSUM XL

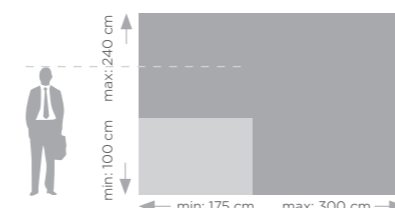
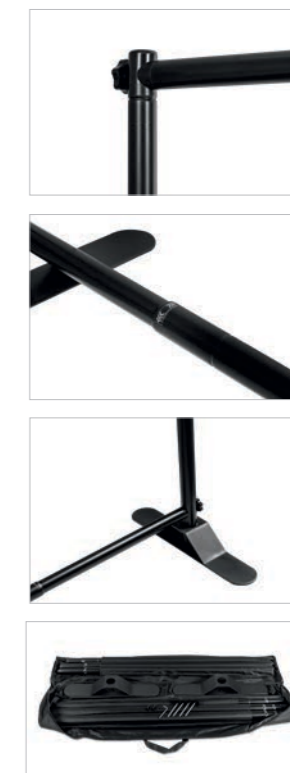

	
5907451661093	9,5 kg

Frame: Ø 32 mm

ADVERTISING WALL ACCESSORIES

BAGS AND CASES

I CASE COUNTER



- 2 in 1 – trolley case and a counter
 - excellent set together with the wall
 - varnished tabletop is an additional option
- This set includes: Counter, PVC Panel board and a tape for graphics assembly.

- 2 in 1 – Koffer und Theke
 - perfekte Präsentation Duo komplett mit Wand
 - Lackierte Arbeitsplatte ist eine Option
- Das Set enthält: Theke, PVC und Klebeband für Grafikmontage.

- 2w1 – trybunka i torba na kółkach
 - doskonały duet prezentacyjny w zestawie ze ścianką
 - lakierowany blat jest opcją dodatkową
- Zestaw zawiera: ambonę, bryt PCV, taśmę do montażu grafiki na ambonie.

I CANVAS BAG



Recommended for walls with graphic not presented on PVC boards.

Empfohlen für Wände mit Grafiken, die nicht auf PVC-Platten dargestellt sind.

Polecana do ścian z grafiką, która nie jest prezentowana na brytach PCV.

Canvas Bag	5907451662946	1 kg
Trolley case	5907451660867	5 kg
Counter	5907451660874	12 kg
Counter top	5907451663073	6 kg

I TROLLEY CASE



- additional padding makes this case very stable
- easy to carry thanks to wheels

- sehr langlebig, mit extra Futter
- einfacher Transport dank Rädern

- bardzo trwała dzięki dodatkowej podszewce
- ułatwiony transport dzięki kółkom

LIGHTING

I HALOGEN



5907451660911

I LED



LED for Mega Seg system	5907451668887
LED for Pop-up & Atlantis walls	5907451660928
LED for Premium Pop-up walls	5907451666418



COUNTERS & BROCHURE HOLDERS

PROMO COUNTERS

- thanks to the simplicity of assembly, they have gained great popularity in many markets
- the walls of this system are made of cellular PVC, mounted to the wooden tabletop and wooden base with velcro straps
- ultralight counter

These sets include: counter top and base packed in transport bag, PVC panel packed in separate transport tube.

- diese Promotheken sind Aufgrund ihrer außergewöhnlich einfachen Installation in vielen Märkten sehr beliebt geworden
- die Theke besteht aus einer Tischplatte (aus Holz) und einer Basis (aus Holz), die ein PVC Paneel verbindet sehr leichte Konstruktion

Diese Sets enthalten: einen Fuß und eine Tischplatte verpackt in einer Transporttasche, PVC Paneel verpackt in einem separaten Transportrohr.

- niezwykle prosty montaż
- trybunka składa się z drewnianego blatu i podstawy, które łączy bryt PCV montowany na rzepy
- bardzo lekka konstrukcja

Zestawy zawierają: blat i podstawę zapakowane w torbę transportową, bryt PVC zapakowany w osobną tubę transportową.

Recommended media and printing technology for this system:



PROMO 0

NEW STRONG TOP

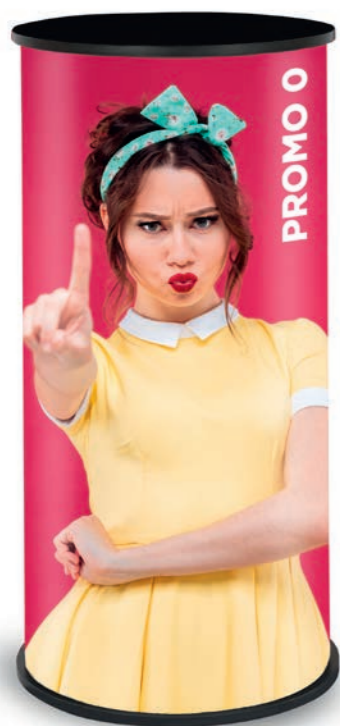

5907451661437



5 kg

Counter

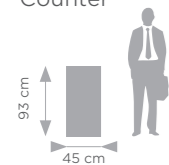

Table top



PROMO 1

NEW STRONG TOP



Product also available with shelf.



5907451661444



10 kg

Counter

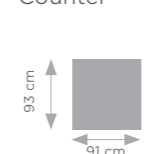
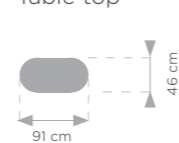

Table top



PROMO 2

BEST SELLER

NEW STRONG TOP

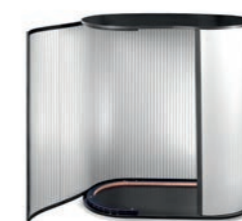

Product also available with shelf.



Counter

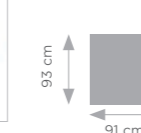
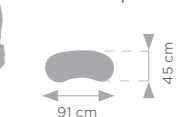

Table top



5907451661451



10 kg

PROMO 3

NEW STRONG TOP



Counter

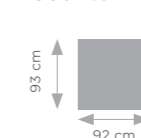
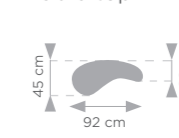

Table top



5907451663714



8 kg

PROMO 4

NEW STRONG TOP



Product also available with shelf.



Counter

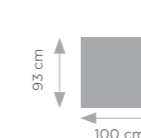
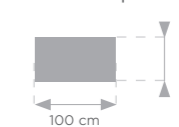

Table top



5907451669112



10 kg

PROMO 2 PLUS COUNTER

- the walls of this system are made of cellular PVC, mounted to the wooden table-top and wooden base with velcro straps
- practical topper

This set includes: counter top, base and topper packed in transport bag, PVC panel packed in separate transport tube.

- die Theke besteht aus einer Tischplatte (aus Holz) und einer Basis (aus Holz), die ein PVC Paneel verbindet
- praktischer Topper

Das Set enthält: einen Fuß, eine Tischplatte und ein Topper verpackt in einer Transporttasche, PVC Paneel verpackt in einem separaten Transportrohr.

- system złożony z drewnianego blatu i podstawy, które łączy bryt PCV montowany za pomocą rzepu
- praktyczny topper

Zestaw zawiera: blat, podstawę i topper zapakowane w torbę transportową, bryt PVC zapakowany w osobną tubę transportową.



5907451661475 | 10,5 kg

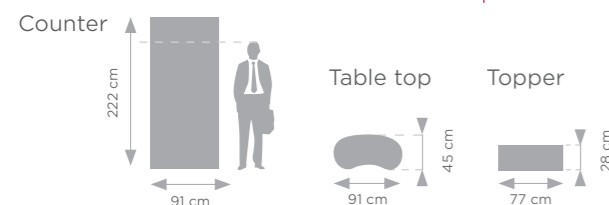

Recommended media and printing technology for this system:



Product also available with shelf.

TOPPER COUNTER

- counter made entirely of PVC board
 - ultralight and stable construction
 - perfect as a tool during supermarket promotions
- This set includes: Topper counter and a carrying bag.

- komplett aus PVC
 - sehr leichte, aber stabile Konstruktion
 - ideal für den Einsatz als Werkzeug bei der Förderung in Supermärkten
- Das Set enthält: Theke Topper und Transporttasche.

- trybunka wykonana w całości z płyty PCV
 - bardzo lekka, a zarazem stabilna konstrukcja
 - idealne rozwiązanie jako narzędzie podczas promocji w supermarketach
- Zestaw zawiera: trybunkę Topper oraz torbę transportową.

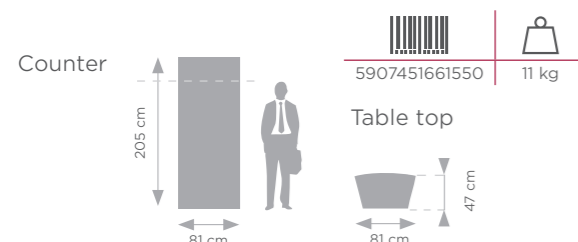

Recommended media and printing technology for this system:



POP-UP VELCRO COUNTER



- "pop up" mechanism - express unfolding
- graphics mounted with Velcro tape
- ultralight, useful, practical shelf in set

The set includes: counter Velcro, wooden top, velcro tape, wooden shelf, transport bag.

- perfekte Ergänzung zu POP-UP Velcro wand
 - Grafik mit Klettverschluss montiert
 - kommt mit einem praktischen Regal
- Das Set enthält: Theke Velcro Pop-up und Canvas Tasche

- doskonałe uzupełnienie ścianki Velcro
- grafika montowana na rzepach
- w zestawie praktyczna półka

Zestaw zawiera: trybunkę Velcro Pop-up, torbę transportową Canvas.

5907451661505 | 12,3 kg



Recommended media and printing technology for this system:



PRESTON COUNTERS

- heavy, very solid and stable construction
- high quality and very impressive graphics mount using a silicone band
- thanks to the use of fabric as a graphic carrier, this counter can be illuminated from inside

These sets include: Preston counter and a transport bag.

- solide und stabile Konstruktion
- hochwertige Verarbeitung
- grafiken mit Silikonband montiert
- dank der Verwendung von Stoff als Träger der Grafik kann der Ladentisch von innen beleuchtet werden

Diese Sets enthalten: Theke Preston und Transporttasche.

- ciężka, solidna i stabilna konstrukcja
- wysoka jakość wykonania
- grafika montowana za pomocą taśmy silikonowej
- dzięki zastosowaniu tkaniny, jako nośnika grafiki, trybunkę można podświetlić od wewnątrz

Zestawy zawierają: trybunkę Preston i torbę transportową typu Canvas.

Recommended media and printing technology for this system:



PRESTON OVAL



5907451661512 | 8 kg

Counter Table top



PRESTON TRIANGLE



5907451661529 | 10 kg

Counter Table top



PRESTON WAIST



5907451663776 | 8 kg

Counter Table top



PRESTON RECTANGLE



5907451661536 | 9 kg

Counter Table top

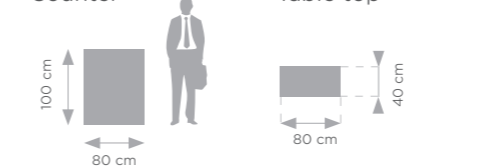

PRESTON XXL



5907451661543 | 27 kg

Counter Table top



PRESTON AUTOMATIC COUNTERS

- automatic and very quick assembly
- stable base and sizable top
- perfect choice for fair and promoting purposes

These sets include: Preston counter and a transport bag.

- Automatische und sehr schnelle Montage
- Stabile Basis und ansehnliche Oberseite
- Perfekte Wahl für Messe - und Werbezwecke

Diese Sets enthalten: Theke Preston und eine Transporttasche.

- automatyczny, bardzo szybki system rozkładania
- stabilna podstawa i spory blat
- grafika montowana za pomocą taśmy silikonowej
- idealne na stoiska targowe lub promocyjne

Zestawy zawierają: trybunkę Preston i torbę transportową typu Canvas.

Recommended media and printing technology for this system:  Fabric Sublimation printing

PRESTON AUTOMATIC OVAL



PRESTON AUTOMATIC RECTANGLE

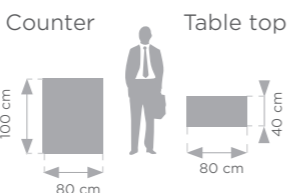

PRESTON AUTOMATIC OVAL LED

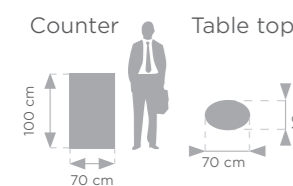

PRESTON AUTOMATIC RECTANGLE LED

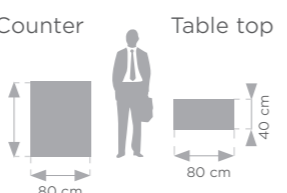

POP-UP COUNTERS

- POP-UP construction
 - graphics mounted on PVC boards
 - attractive appearance
- The set includes: Pop Up counter, PVC panel, 3M magnetic tape, transport bag.

- Grafik auf PVC Paneelen montiert
 - leichtes POP-UP Konstruktion
 - attraktives Aussehen
- Diese Sets enthalten: Theke PopUp und Canvas Tasche.

- stelaż typu POP-UP - błyskawiczne rozłożenie systemu
 - grafika montowana na brytach PCV
 - lekka konstrukcja i atrakcyjny wygląd
- Zestawy zawierają: trybunkę Pop-up, torbę transportową typu Canvas.

POP-UP 2x1

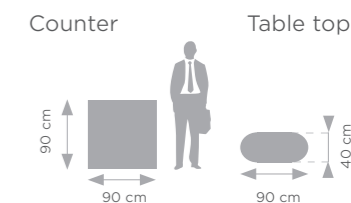

Recommended media and printing technology for this systems:



POP UP 2x2

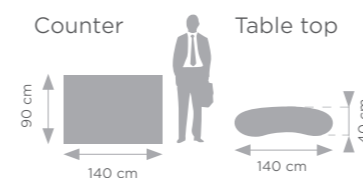

Recommended media and printing technology for this systems:



LUNIX™ COUNTER



- double-sided system
 - **wide aluminium profile (12 cm)**
 - integrated LED lighting
 - no tools assembly
 - silicon tape mounted printout
 - wheeled transport bag
- The set includes: LUNIX™ counter, power adapter, transport bag.

- doppelseitige, auffällige Konstruktion
 - **stabiler Aluminiumrahmen (12 cm)**
 - integrierte LED-Beleuchtung
 - Silikonband befestigte Druck
 - werkzeuglose Montage
 - Tasche auf Rädern
- Das Set enthält: Theke LUNIX™, Netzteil, Transporttasche.

- dwustronny system
 - **szeroki profil aluminiowy (12 cm)**
 - zintegrowane oświetlenie LED
 - montaż bez narzędzi
 - wydruk na tkaninie montowany na taśmie silikonowej
 - torba na kółkach
- Zestaw zawiera: trybunkę LUNIX™, zasilacz, torbę transportową.

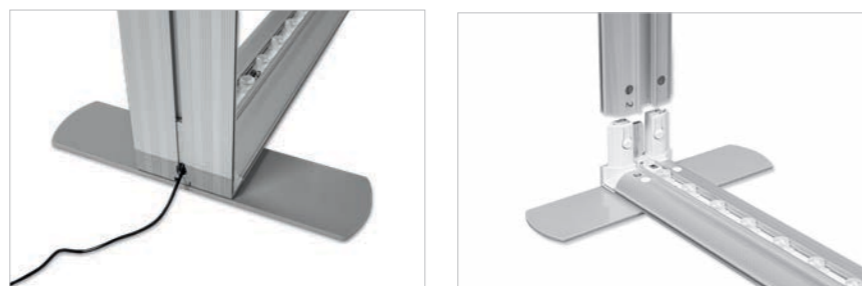

Recommended media and printing technology for this system:



LED BOX™ COUNTER



- double-sided LED system
 - aluminium frame - 8 cm
 - no tools assembly
 - silicon tape mounted printout
- The set includes: LED BOX counter, power adapter, transport bag.

- beidseitiges LED-System
 - Rahmenbreite - 8 cm
 - Montage ohne Werkzeug
 - Druck auf Stoff, montiert auf Silikonband
- Das Set enthält: Theke LED BOX, Netzteil, Transporttasche.

- dwustronny, podświetlany system
 - profil aluminiowy - 8 cm
 - montaż bez narzędzi
 - wydruk na tkaninie montowany na taśmie silikonowej
- Zestaw zawiera: trybunkę LED BOX, zasilacz, torbę transportową.

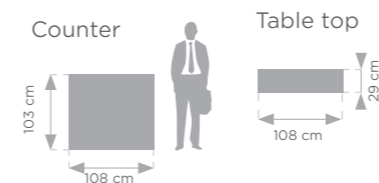
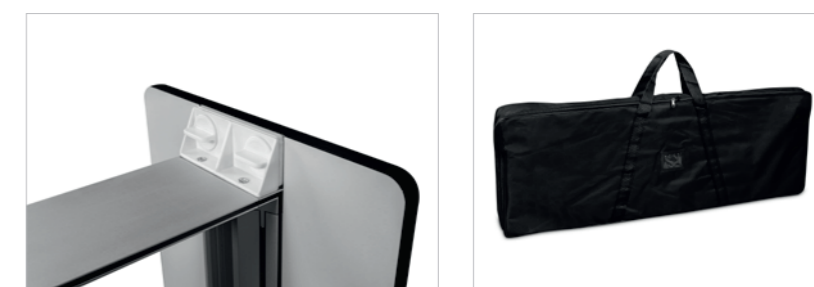

Recommended media and printing technology for this system:



LED BOX™ COUNTER WITH SHELF

NEW!



NO TOOLS

6,5 cm

ALUMINIUM PROFILE



SILICONE TAPE MOUNTED PRINTOUT



- LED counter with practical shelf
- aluminium frame - 6,5 cm
- no tools assembly
- silicon tape mounted printout
- wheeled transport bag

The set includes: LED BOX with shelf counter, blackback material, power adapter, transport bag.

- LED-Theke mit praktischem Regal
- Rahmenbreite - 6,5 cm
- Montage ohne Werkzeug
- Druck auf Stoff, montiert auf Silikonband
- Rolltasche

Das Set enthält: Theke LED-BOX mit Regal, blackback Material, Netzteil, Transporttasche.

- trybunka LED z praktyczną półką
- profil aluminiowy - 6,5 cm
- montaż bez narzędzi
- wydruk na tkaninie montowany za pomocą taśmy silikonowej
- torba na kółkach

Zestaw zawiera: trybunkę LED BOX z półką, materiał blackback, zasilacz, torbę transportową.

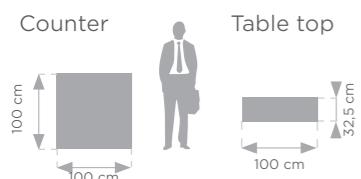

Recommended media and printing technology for this system:



BACKLIGHT COUNTER

NEW!



70 LED BULBS



SILICONE TAPE MOUNTED PRINTOUT



NO TOOLS

- LED curtain enables the entire printout to be evenly illuminated

- the back of the curtain is opaque, which allows for even better highlighting of the graphics
- aluminium light strips
- aluminium profile - 6,5 cm

The set includes: BACKLIGHT counter, LED curtain, power adapter, transport bag.

- Aluminium-Lichtleisten mit einer großen Anzahl von LEDs beleuchten den gesamten Druck gleichmäßig
- Rahmenbreit - 6,5 cm

Das Set enthält: Theke BACKLIGHT, LED-Vorhang, Netzteil, Transporttasche.

- kurtyna LED z dużą ilością żarówek pozwala na równomierne oświetlenie wydruku

- aluminiowe listwy świetlne
- profil aluminiowy - 6,5 cm

Zestaw zawiera: trybunkę BACKLIGHT, zasilacz, torbę transportową.

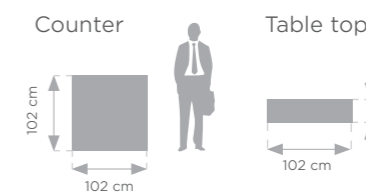



Recommended media and printing technology for this system:



BROCHURE HOLDERS

MONTANA SILVER



-  two-sided access to presented materials
 - designed for brochures in A4 and A3 format
 - small dimension after folding
 - made of aluminium and metal
-  zwei-Wege-Zugriff auf die eingereichten Katalogen
 - für A4 und A3 Kataloge geeignet
 - kleine Größe nach dem Falten
 - stand aus Aluminium und Metall
-  dwustronny dostęp do prezentowanych materiałów
 - dla katalogów w formacie A4 i A3
 - niewielkie rozmiary po złożeniu
 - stojak wykonany z aluminium i metalu





Product packed in transport bag or aluminium case.

		
A4	5907451660553	5,2 kg
A3	5907451669365	7,5 kg

MONTANA BLACK



-  two-sided access to presented materials
 - designed for brochures in A4 and A3 format
 - small dimension after folding
 - made of aluminium and metal
-  zwei-Wege-Zugriff auf die eingereichten Katalogen
 - für A4 und A3 Kataloge geeignet
 - kleine Größe nach dem Falten
 - stand aus Aluminium und Metall
-  dwustronny dostęp do prezentowanych materiałów
 - dla katalogów w formacie A4 i A3
 - niewielkie rozmiary po złożeniu
 - stojak wykonany z aluminium i metalu

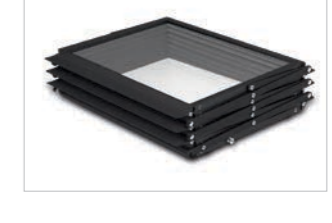

		
A4	5907451668962	5,2 kg
A3	5907451668955	7,5 kg

BOSTON

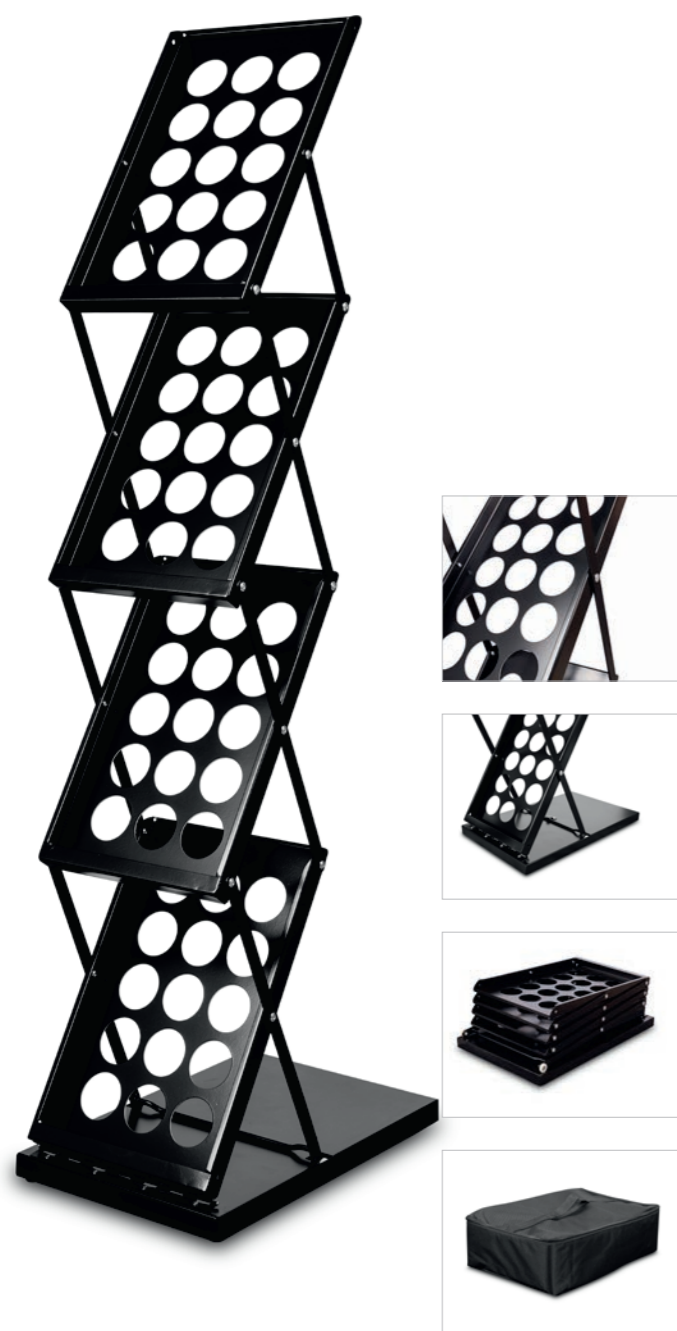

- bestseller
 - made entirely of metal, powder coated black
 - small dimension, lightweight frame
- bestseller
 - Boston ist komplett aus schwarz pulverbeschichtetem Metall gefertigt
 - kleine Größe und leichtes Design
- bestseller
 - wykonany z metalu malowanego proszkowo na kolor czarny
 - niewielkie rozmiary i lekka konstrukcja

A4 | | 4,3 kg

ATLANTA



- solid metal construction
 - two-sided access to presented materials
 - small size after folding
- robuste Konstruktion aus Metall
 - beidseitiger Zugang zu A4-Material
 - geringe Größe nach dem Falten
- solidna metalowa konstrukcja
 - dwustronny dostęp do prezentowanych materiałów
 - niewielkie rozmiary po złożeniu

A4 | | 6,6 kg

COLUMBIA



- pockets made of thick transparent plexiglass board
 - chromed base
 - a grip making it easy to handle
 - handy backpack included
- Taschen aus dickem, transparentem Plexiglas hergestellt
 - verchromte Basis
 - ein Griff für den einfachen Transport
 - bequemer Rucksack enthaltet
- kieszenie wykonane z grubej, przezroczystej pleksi
 - chromowana podstawa
 - uchwyt, który ułatwia przenoszenie
 - poręczny plecak w komplecie

A4 | | 5 kg

LINCOLN



- extremely durable and strong stand
 - made of metal, powder coated gray and black
 - designed for catalogs and brochures in A4 format
 - bag included
- extrem starke Konstruktion
 - komplett aus pulverbeschichtetem Metall
 - für A4 Kataloge geeignet
 - Tasche enthaltet
- wyjątkowo trwała i mocna konstrukcja
 - w całości wykonany z metalu malowanego proszkowo na kolor szary i czarny
 - przeznaczony na ulotki w formacie A4
 - torba w komplecie

A4 | | 6,5 kg

COUNTER DALLAS



- 2in1 - counter and brochure holder
- catalogs in A4 and A3 format will fit here
- stable construction

- 2in1: Theke und Prospekthalter
- geeignet für A4 und A3 Kataloge
- stabile Konstruktion

- 2w1 - trybunka i stojak na ulotki
- dostosowany do katalogów w formacie A4 i A3
- stabilna konstrukcja



5907451663592



10 kg

COUNTER CONCORD



- 2in1 - counter and brochure holder
- catalogs in A4 format will fit here
- elegant table top made of light wood
- counter folds into small dimensions and fits in a durable, elegant aluminum case

- 2in1: Theke und Prospekthalter
- geeignet für A4 Kataloge
- elegante Tischplatte aus Holz
- die Theke lässt sich in kleinen Abmessungen zusammenfalten und passt in ein elegantes Aluminiumgehäuse

- 2w1 - trybunka i stojak na ulotki
- dostosowany do katalogów w formacie A4
- elegancki blat wykonany z drewna
- konstrukcja składa się w niewielkie wymiary i mieści w walizce aluminiowej dołączonej do zestawu



A4 5907451660577



8 kg

VIRGINIA

- 2in1 - info stand and brochure holder in one
- A4 or universal pocket
- snap frame for customized poster
- very stable and strong system

- 2in1 - Infostand und Broschürenhalter in einem
- A4 oder Universaltasche
- Schnapprahmen für individuelles Poster
- sehr stabiles und starkes System

- 2w1 - stojak info + stojak na ulotki
- kieszon A4 lub kieszeń do formatów uniwersalnych
- ramka OWZ - wydrukuj własny plakat
- bardzo solidna i ciężka konstrukcja



5907451664889



9 kg



POSTER RAILS

POSTERLEISTEN
LISTWY PLAKATOWE



- wide choice of sizes - custom sizes available on request
- possibility of mounting to a wall or ceiling
- "Express Clip" system - quick and simple assembly and graphics exchange
- thick profile made of anodized aluminum

This set includes: top rail with hooks and bottom rail.

- große Auswahl an Breiten
- Möglichkeit der Montage an der Wand oder Decke
- „Express Clip“ System - sofortige und einfache Montage und Austausch von Grafiken
- elegantes Aussehen
- dickes Profil aus eloxiertem Aluminium

Das Set enthält: obere Schiene mit Haken und untere Schiene.

- duży wybór szerokości - możliwość wykonania listew pod wymiar klienta
- możliwość montażu do ściany lub sufitu
- system „Express Clip” - błyskawiczny i prosty montaż i wymiana grafiki
- elegancki wygląd
- gruby profil wykonany z aluminium anodowanego

Zestaw zawiera: listwę górną z zawieszkami i listwę dolną.

Recommended media and printing technology for this system:



STANDARD

40 cm (silver)	5907451662038	0,20 kg
60 cm (silver)	5907451661635	0,30 kg
85 cm (silver)	5907451660249	0,40 kg
100 cm (silver)	5907451660256	0,45 kg
120 cm (silver)	5907451660263	0,55 kg
150 cm (silver)	5907451660270	0,70 kg
200 cm (silver)	5907451660287	0,90 kg
60 cm (black)	5907451668344	0,30 kg
85 cm (black)	5907451668351	0,40 kg
100 cm (black)	5907451668368	0,45 kg
120 cm (black)	5907451668375	0,55 kg
150 cm (black)	5907451668382	0,70 kg
200 cm (black)	5907451668399	0,90 kg



Available colours:

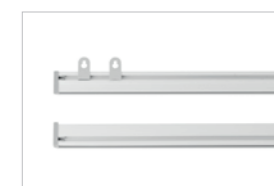

SLIM

40 cm	5907451662045	0,20 kg
60 cm	5907451662052	0,30 kg
85 cm	5907451662069	0,40 kg
100 cm	5907451662076	0,45 kg
120 cm	5907451662083	0,55 kg
150 cm	5907451662090	0,70 kg
200 cm	5907451663707	0,90 kg

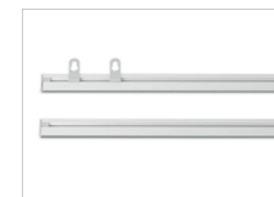

CLIP

40 cm	5907451662526	0,20 kg
60 cm	5907451662533	0,30 kg
85 cm	5907451662540	0,40 kg
100 cm	5907451662496	0,45 kg
120 cm	5907451662502	0,55 kg
150 cm	5907451662519	0,70 kg

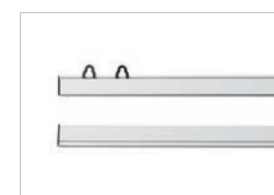

TWIN

40 cm	5907451662236	0,20 kg
60 cm	5907451662243	0,30 kg
85 cm	5907451662250	0,40 kg
100 cm	5907451662267	0,45 kg
120 cm	5907451662274	0,55 kg
150 cm	5907451662281	0,70 kg



VERTICO HANGING FRAMES



- aluminium profile: 25 mm**
 - poster cover with UV-filter protects the printout from fading graphic colours
 - "clip-clap" system - quick and simple assembly and graphics exchange
 - vertical or horizontal assembly
- Profilbreite (aluminium): 25 mm**
 - Plakathülle mit UV-Filter schützt den Ausdruck vor dem Verblässen der Grafikfarben
 - "Clip-Clap" System - sofortige und einfache Montage und Austausch von Grafiken
 - vertikale oder horizontale Montage
- profil aluminiowy: 25 mm**
 - osłona na plakat z filtem UV
 - system „clip-clap” - błyskawiczny i prosty montaż oraz wymiana grafiki
 - możliwy montaż pionowy lub poziomy
- doublesided aluminium frame: 32 mm**
 - mounted on the ceiling
 - simple and elegant design
 - "clip-clap" system - quick and simple graphics assembly and exchange
- doppelseitiger Aluminiumrahmen: 32 mm**
 - an der Decke montiert
 - einfaches und elegantes Design
 - „Clip-Clap“-System - schnelle und einfache Montage und Austausch der Grafiken
- ramka aluminiowa o szerokim profilu: 32 cm**
 - możliwość podwieszenia pod sufitem
 - prosty i elegancki design
 - system „clip-clap”- błyskawiczny i prosty montaż oraz wymiana plakatu

Recommended media and printing technology for this system: Paper Solvent, UV, Latex

A2	5907451665688	2,1 kg
A1	5907451665671	3,4 kg
B2	5907451665701	2,7 kg
B1	5907451665695	4,3 kg



SNAP FRAMES STANDARD

- aluminium profile: 25 mm**
 - poster cover with UV-filter protects the printout from fading graphic colours
 - "clip-clap" system - quick and simple assembly and graphics exchange
 - vertical or horizontal assembly
- Profilbreite (aluminium): 25 mm**
 - Plakathülle mit UV-Filter schützt den Ausdruck vor dem Verblässen der Grafikfarben
 - "Clip-Clap" System - sofortige und einfache Montage und Austausch von Grafiken
 - vertikale oder horizontale Montage
- profil aluminiowy: 25 mm**
 - osłona na plakat z filtem UV
 - system „clip-clap” - błyskawiczny i prosty montaż oraz wymiana grafiki
 - możliwy montaż pionowy lub poziomy

Recommended media and printing technology for this system: Paper Solvent, UV, Latex

SNAP FRAMES SILVER

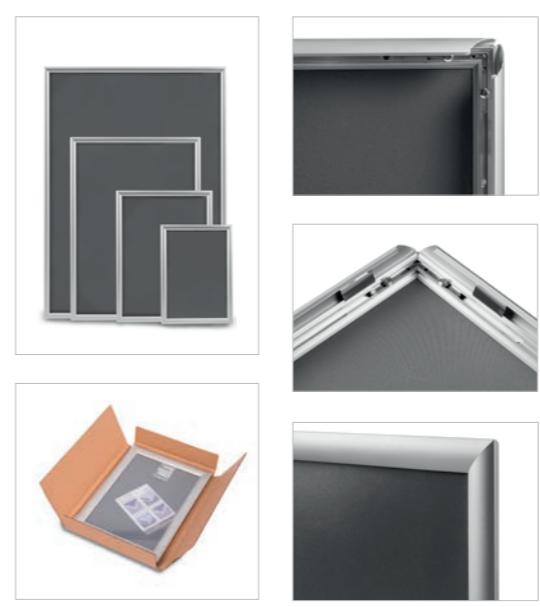

A5	5907451662557	0,30 kg
A4	5907451661567	0,45 kg
A3	5907451661574	0,65 kg
A2	5907451661581	1,15 kg
A1	5907451661598	1,90 kg
A0	5907451661604	3,60 kg
B3	5907451662564	0,95 kg
B2	5907451661628	2,00 kg
B1	5907451661611	2,60 kg

SNAP FRAMES BLACK



A4	5907451664872	0,45 kg
A3	5907451664865	0,65 kg
A2	5907451664858	1,15 kg
A1	5907451664841	1,90 kg
B3	5907451665787	0,95 kg
B2	5907451665794	2 kg
B1	5907451665800	2,6 kg

SNAP FRAMES PREMIUM



- **aluminium profile: 32 mm**
- "clip-clap" system – quick and simple assembly and graphics exchange
- vertical or horizontal assembly
- poster cover with UV-filter protects the printout from fading graphic colours

- **Profilbreite (aluminium): 32 mm**
- "Clip-Clap" System – sofortige und einfache Montage und Austausch von Grafiken
- vertikale oder horizontale Montage
- Plakathülle mit UV-Filter schützt den Ausdruck vor dem Verblässen der Grafikfarben

- **szeroki profil aluminiowy: 32 mm**
- system „clip-clap” – błyskawiczny i prosty montaż oraz wymiana grafiki
- możliwy montaż pionowy lub poziomy
- osłona na plakat z filtrem UV



A3	5907451664230	1,20 kg
A2	5907451664223	1,85 kg
A1	5907451664216	2,80 kg

Recommended media and printing technology for this system:



MAGNETIC FRAMES

MAGNETIC

- simple and elegant design
 - glossy anti-reflective foil holds the printout with magnetic strips
 - assembly without tools
 - value for money
- einfaches und elegantes Design
 - die glänzende Antireflexionsfolie hält den Ausdruck mit Magnetstreifen
 - Montage ohne Werkzeuge
 - Preis-Leistungsverhältnis
- prosty i elegancki design
 - błyszcząca folia antyrefleksyjna przytrzymuje wydruk przy pomocy zamontowanych do niej i do ramki pasków magnetycznych
 - montaż bez narzędzi
 - dobry stosunek jakości do ceny



A5 (silver)	6956526031285
A4 (silver)	6956526031278
A3 (silver)	6956526031261
A4 (black)	5907451663424
A3 (black)	5907451662670

MAGNETIC REWERS

- front-glued frame
 - double-sided
 - simple and elegant design
 - assembly without tools
- Vorne geklebt Rahmen
 - doppelseitig
 - einfaches und elegantes Design
 - montage ohne Werkzeuge
- ramka przyklejana przodem
 - prosty i elegancki wygląd
 - dwustronna
 - montaż bez narzędzi



A4 (silver)	6956526031513
A3 (silver)	6956526031520
40x60 cm (silver)	6956526031537
A4 (black)	5907451665015



MAGNETIC SAFETY

- magnetic frame in warning version
 - necessary in production halls, warehouses, parking lots and places under special supervision
 - simple and elegant design
 - glossy anti-reflective foil holds the printout with magnetic strips
 - assembly without tools
- magnetisches Rahmen in Warnung Version
 - unverzichtbar in Produktionshallen, Lagerhallen, Parkplätzen und Orten, die unter besonderer Aufsicht stehen
 - einfaches und elegantes Design
 - die glänzende Antireflexionsfolie hält den Ausdruck mit Magnetstreifen
 - Montage ohne Werkzeuge
- ramka magnetyczna w wersji ostrzegawczej niezbędna w halach produkcyjnych, magazynach, parkingach i miejscach objętych szczególnym nadzorem
 - błyszcząca folia antyrefleksyjna przytrzymuje wydruk przy pomocy zamontowanych do niej i do ramki pasków magnetycznych
 - montaż bez narzędzi



A4	5907451663486
A3	5907451663479

Recommended media and printing technology for this system:



DOOR SIGNS

SONIC

- one of the most popular wall door signs on the market
 - quick assembly
 - popular "clip-clap" system - graphics change takes few seconds
 - anti-reflective film included
 - mounting with fixing bolts or double-sided tape
 - value for money
- eines der beliebtesten Wandtürschilder auf dem Markt
 - schnelle Montage
 - beliebtes „Clip-Clap“ - System - der Grafikwechsel dauert einige Sekunden
 - Antireflexfilm enthalten
 - Montage mit Befestigungsschrauben oder doppelseitigem Klebeband
 - Preis-Leistungsverhältnis
- jedne z najpopularniejszych tabliczek przydrzwiowych na rynku
 - szybki montaż
 - system „clip-clap“ - wymiana wizytówki zabiera kilka sekund
 - montaż przy pomocy śrub lub taśmy dwustronnej
 - w komplecie folia antyrefleksyjna
 - dobry stosunek jakości do ceny



A6	6956526031179
A5	6956526031162
A4	6956526031155

Recommended media and printing technology for this system:



ELITE

- aspecto muy elegante
 - el más elegido para interiores de estilo moderno
 - el gráfico se puede sustituir desatornillando dos separadores que sujetan dos láminas de plexiglás
 - utilice este sistema si no necesita cambiar los gráficos con frecuencia
- sehr eleganter Look
 - am häufigsten für moderne Innenräume gewählt
 - die Grafik kann ersetzt werden, indem zwei Abstandhalter mit zwei Plexiglasplatten abgeschraubt werden
 - Verwenden Sie dieses System, wenn Sie die Grafiken nicht häufig ändern müssen
- wyjątkowo elegancki wygląd
 - najczęściej wybierany do wnętrz nowoczesnych
 - wymiana treści poprzez odkręcenie dystansów przytrzymujących dwie płytki pleksi
 - tabliczka sugerowana do rozwiązań niewymagających częstej wymiany grafiki



A6	6956526032121
148x148 mm	6956526032138
A5	6956526032145
A4	6956526032169

Recommended media and printing technology for this system:



GERT

- modern design
 - classic ash-grey color which fits any interior design
 - graphics may be replaced with a single move, just by opening the plate clips
 - no tools required
- modernes Aussehen, einfaches und elegantes Design
 - klassische Aschefarbe, um alle Innenräume zu passen
 - der Austausch des Inhalts erfolgt durch das Öffnen der Schnellverschlüsse
 - keine Werkzeuge erforderlich
- nowoczesny wygląd
 - klasyczny popielaty kolor pasuje do wszystkich wnętrz
 - wymiana treści poprzez otwarcie zatrzasków tabliczki, jednym ruchem
 - brak konieczności posiadania jakichkolwiek narzędzi



149x64 mm	6956526032084
149x105,5 mm	6956526032091
149x148,5 mm	6956526032107

Recommended media and printing technology for this system:



PURO

- modern look
 - easy content exchange
 - made of a very thick aluminium profile
 - mounting with double-sided tape
- moderner Look
 - einfacher Inhaltsaustausch
 - aus einem sehr dicken Aluminiumprofil
 - Montage mit doppelseitigem Klebeband
- nowoczesny wygląd
 - łatwa wymiana treści
 - tabliczka z grubego profilu aluminiowego
 - montaż przy pomocy taśmy dwustronnej



180x50 mm	6956526031711
180x70 mm	6956526031728
210x90 mm	6956526031735

Recommended media and printing technology for this system:



MANTA

- minimalistic look
 - suitable for interiors designed in bright - Scandinavian style
 - this holder is equipped with a white frame on which front plexiglass pane is installed (with clips)
- minimalistisches Design
 - dieses Produkt ist besonders für helle Innenräume im skandinavischen Stil geeignet
 - das Schild hat einen weißen Rahmen, auf den das vordere Plexiglas aufgesetzt wird (mit Schnellverschlüssen)
- minimalistyczny wygląd
 - sprawdzi się szczególnie we wnętrzach o skandynawskim, jasnym stylu
 - tabliczka posiada białą ramkę, na którą nakłada się (przy pomocy zatrzasków) przednią szybkę pleksi





A6	6956526050989
A5	6956526050996
A4	6956526051009

Recommended media and printing technology for this system:



ACRYLIC STANDS CRYSTAL

- 
 - double sided acrylic stand
 - ideal for placing on a table / counter in various public spaces, e.g. restaurants, banks, hotels
 - wide base ensures stability
 - versatile appearance
- 
 - doppelseitige acryl Ständer
 - ideal für die Platzierung auf dem Tisch / Theke in den Innenräumen von verschiedenen öffentlichen Räumen, wie Restaurants, Banken, Hotels
 - breite basis garantiert stabilität
 - universelles Aussehen
- 
 - dwustronny stojak akrylowy
 - idealnie sprawdzi się do postawienia na stole / ladzie we wnętrzach różnych przestrzeni publicznych np. w restauracjach, bankach, hotelach
 - szeroka podstawa gwarantuje stabilność
 - uniwersalny wygląd

Recommended media and printing technology for this system:



Paper
Solvent, UV, Latex

	
A7	6956526050132
A6	6956526050156
A5	6956526050163
A4	6956526050170



PLATINUM

- 
 - acrylic stand with a slight angle of inclination
 - minimalistic look
 - ideal for placing on a table / counter in the interiors of various public spaces, e.g. in banks, hotels, corporate receptions, etc.
 - wide base with interesting design guarantees stability
- 
 - acryl-Ständer mit leichtem Neigungswinkel
 - minimalistisches Design
 - ideal für die Platzierung auf dem Tisch / Theke in den Innenräumen der verschiedenen öffentlichen Räume, wie Banken, Hotels, Empfänge von Unternehmen, etc.
 - breite Basis mit interessantem Design garantiert Stabilität
- 
 - stojak akrylowy o lekkim kącie nachylenia
 - minimalistyczny wygląd
 - idealnie sprawdzi się do postawienia na stole / ladzie we wnętrzach różnych przestrzeni publicznych np. w bankach, hotelach, recepcjach firm itp.
 - szeroka podstawa o ciekawym designie gwarantuje stabilność

Recommended media and printing technology for this system:







Paper
Solvent, UV, Latex

	
A5	6956526053638
A4	6956526053645



VISTA HORIZONTAL

- 
 - heavy acrylic stand with a broad base
 - elegant look
 - horizontal graphic presentation
 - double-sided
- 
 - schwerer Acrylständer mit breiter Basis
 - elegantes Aussehen
 - horizontale grafische Darstellung
 - doppelseitig
- 
 - masywny, akrylowy stojak z szeroką podstawą
 - wyjatkowo elegancki wygląd
 - prezentacja treści w pozycji poziomej
 - dwustronny

	
A6	6956526053775
A5	6956526053768
A4	6956526053751



Recommended media and printing technology for this system:



Paper
Solvent, UV, Latex



VISTA VERTIKAL

- 
 - heavy acrylic stand with a broad base
 - elegant look
 - vertikal graphic presentation
 - double-sided
- 
 - schwerer Acrylständer mit breiter Basis
 - elegantes Aussehen
 - vertikale grafische Darstellung
 - doppelseitig
- 
 - masywny, akrylowy stojak z szeroką podstawą
 - wyjatkowo elegancki wygląd
 - prezentacja treści w pozycji pionowej
 - dwustronny

	
A6	6956526053737
A5	6956526053720
A4	6956526053713

Recommended media and printing technology for this system:



Paper
Solvent, UV, Latex



ROD SYSTEMS

- popular ROD system for wall to wall hanging adv boards
- made from high quality aluminium
- minimalistic and elegant appearance
- long steel rope (300 cm/400 cm) included
- adjustable steel rope length
- anchors and screws for mounting included

- beliebtes ROD-System zum Aufhängen von Adv-Boards
- aus hochwertigem Aluminium gefertigt
- minimalistisches und elegantes Erscheinungsbild
- langes Stahlseil (300 cm/400 cm) enthalten
- einstellbare Stahlseillänge
- Anker und Schrauben zur Montage enthalten

- popularny system ROD do zawieszania tablic reklamowych
- wysokiej jakości aluminium
- minimalistyczny i elegancki wygląd
- w zestawie długa stalowa lina (300 cm/400 cm)
- regulowana długość liny stalowej
- w komplecie kołki i śruby do montażu

WALL TO WALL SYSTEM

WAND ZU WAND SYSTEM
SYSTEM ŚCIANA-ŚCIANA

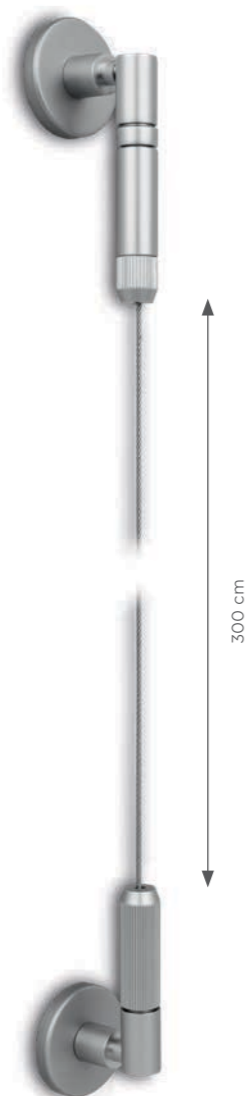

300 cm



		ROD
5907451664490	0,5 kg	300 cm

WALL TO FLOOR/CEILING SYSTEM

WAND ZUM BODEN-/DECKENSYSTEM
SYSTEM ŚCIANA-PODŁOGA/SUFIT

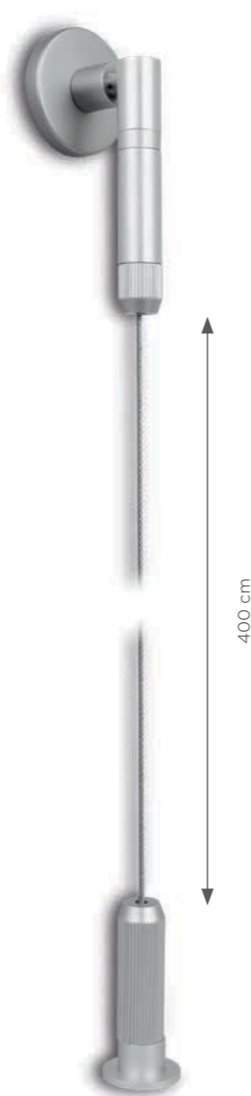

400 cm



		ROD
5907451664513	0,4 kg	400 cm

CEILING TO FLOOR SYSTEM

DECKEN ZU BODEN SYSTEM
SYSTEM SUFIT-PODŁOGA

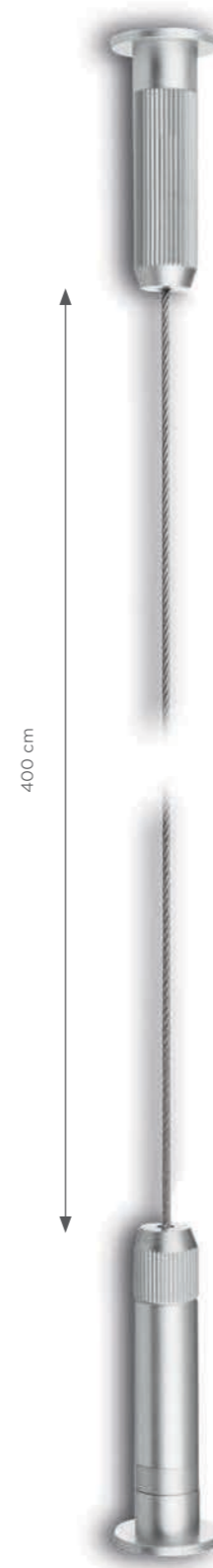

400 cm



		ROD
5907451664506	0,3 kg	400 cm

CEILING TO BOARD SYSTEM

DECKEN-BORD SYSTEM
SYSTEM SUFIT-TABLICA

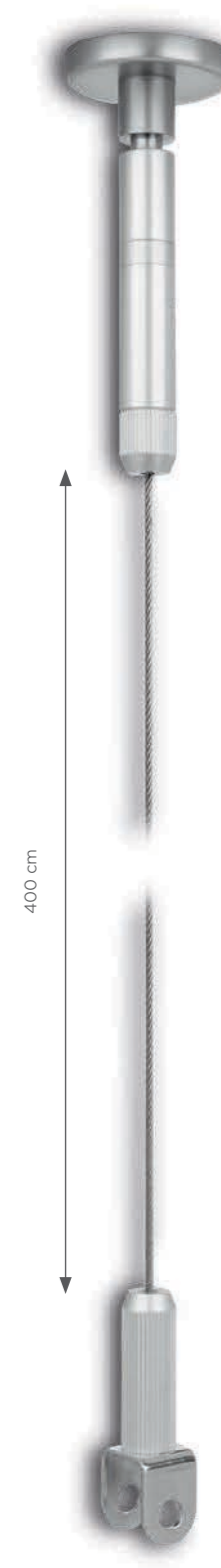

400 cm



		ROD
5907451664520	0,4 kg	400 cm

ACCESSORIES



SINGLE-SIDE BOARD HOLDER

EINSEITIGER BORDHALTER
JEDNOSTRONNE MOCOWANIE TABLICY



5907451664537 0,1 kg

DOUBLE-SIDE BOARD HOLDER

DOPPELSEITIGER BORDHALTER
DWUSTRONNE MOCOWANIE TABLICY



5907451664544 0,15 kg

STANDOFFS WANDHALTERUNG DYSTANSE

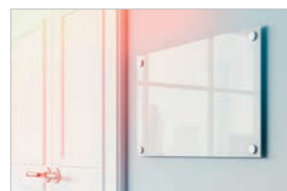

- designed for mounting all types of advertising boards
- made of aluminium
- high quality
- multiple sizes
- two color versions: black mat and silver satin

- entworfen, um alle Arten von Werbetafeln zu installieren
- aus Aluminium hergestellt
- hochwertige Verarbeitung
- mehrere Größen
- zwei Farbversionen: schwarze Matte und Silber Satin

- przeznaczone do montażu wszystkich rodzajów tablic reklamowych
- wykonane z aluminium
- wysoka jakość
- wiele rozmiarów
- dostępne w kolorze srebrnym i czarnym

SILVER SATIN



Size	Barcode	Product Code
13x13 mm	5907451664551	5907451664551
13x19 mm	5907451664575	5907451664575
15x20 mm	5907451664599	5907451664599
15x25 mm	5907451664612	5907451664612
19x19 mm	5907451664636	5907451664636
19x25 mm	5907451664650	5907451664650
25x29 mm	5907451664674	5907451664674
25x25 mm	5907451664698	5907451664698

SILVER MAT



Size	Barcode	Product Code
13x13 mm	5907451668108	5907451668108
13x19 mm	5907451668115	5907451668115
15x20 mm	5907451668122	5907451668122
15x25 mm	5907451668139	5907451668139
19x19 mm	5907451668146	5907451668146
19x25 mm	5907451668153	5907451668153
25x19 mm	5907451668160	5907451668160
25x25 mm	5907451668177	5907451668177

BLACK MAT



Size	Barcode	Product Code
13x13 mm	5907451664568	5907451664568
13x19 mm	5907451664582	5907451664582
15x20 mm	5907451664605	5907451664605
15x25 mm	5907451664629	5907451664629
19x19 mm	5907451664643	5907451664643
19x25 mm	5907451664667	5907451664667
25x19 mm	5907451664681	5907451664681
25x25 mm	5907451664704	5907451664704



PAVEMENT SIGNS

AURORA

- aluminium profile: 25 mm
 - double-sided
 - very resistant to weather conditions
 - clip-clap system - quick graphics exchange
 - poster cover with UV-filter protects the printout from fading colours
- The set includes: stand Aurora in a carton box.

- Profilbreite (aluminium): 25 mm
 - doppelseitig
 - sehr langlebig Allwetter-Design
 - System „clip-clap“ - sehr schneller Grafikaustausch
 - Plakathülle mit UV-Filter schützt den Ausdruck vor dem Verblässen der Grafikfarben
- Das Set enthält: Kundenstopper Aurora, Einzelkarton.

- profil aluminiowy: 25 mm
 - dwustronna prezentacja grafiki
 - wysoka wytrzymałość na warunki atmosferyczne
 - system „clip-clap“ - błyskawiczna wymiana grafik
 - osłona na plakat z filtrem UV
- Zestaw zawiera: potykacz Aurora, indywidualny karton.

Recommended media and printing technology for this system:



AURORA SILVER



A2	5907451662021	6,75 kg
A1	5907451662151	9,00 kg
A0	5907451662144	12,60 kg
B2	5907451662182	5,00 kg
B1	5907451662175	9,20 kg

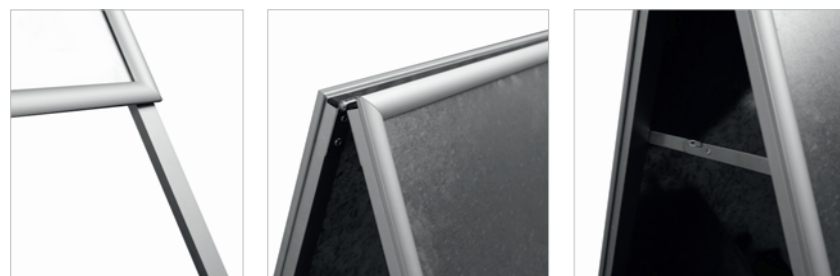

AURORA BLACK

A2	5907451664384	6,75 kg
A1	5907451664377	9,00 kg

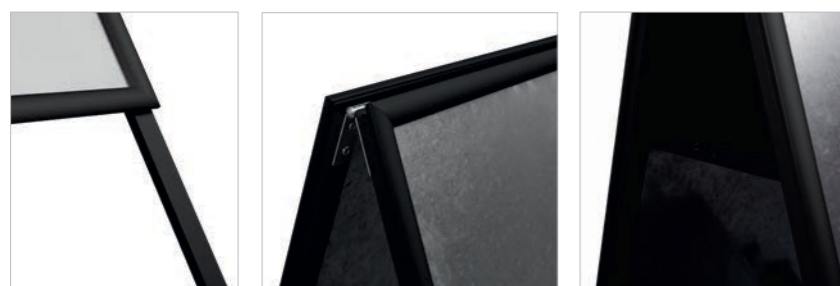

SPIDER



- aluminium profile: 32 mm
 - extremely stable even in strong winds
 - double sided
 - very weather resistant
 - clip-clap system - quick graphics exchange
 - poster cover with UV-filter protects the printout from fading colours
- This set includes: stand Spider in individual box.

- Profilbreite (aluminium): 32 mm
 - extrem stabil auch bei starkem Wind
 - doppelseitig
 - sehr witterungsbeständig
 - System „clip-clap“ - sehr schneller Grafikaustausch
 - Plakathülle mit UV-Filter schützt den Ausdruck vor dem Verblässen der Grafikfarben
- Das Set enthält: Kundenstopper Spider, Einzelkarton.

- profil aluminiowy: 32 mm
 - wyjątkowo stabilny nawet przy silnym wietrze
 - dwustronna prezentacja grafiki
 - bardzo odporny na warunki atmosferyczne
 - system „clip-clap“ - błyskawiczna wymiana grafik
 - osłona na plakat z filtrem UV
- Zestaw zawiera: potykacz Spider, indywidualny karton.



A1	5907451662205	8,8 kg

Recommended media and printing technology for this system:



HAMPTON

- aluminium profile: 32 mm
- base can be filled with water or sand
- extremely stable even in strong wind
- double sided
- very weather resistant
- clip-clap system – quick graphics exchange
- poster cover with UV-filter protects the printout from fading colours

This set includes: stand Hampton in a carton box.

- Profilbreite (aluminium: 32 mm)
- die Basis kann mit Wasser oder Sand gefüllt werden
- extrem stabil auch bei starkem Wind
- doppelseitig
- sehr witterungsbeständig
- System „clip-clap“ – sehr schneller Grafikaustausch
- Plakathülle mit UV-Filter schützt den Ausdruck vor dem Verblässen der Grafifarben

Das Set enthält: Kundenstopper Hampton, Einzelkarton.

- profil aluminiowy: 32 mm
- podstawa może być wypełniona wodą lub piaskiem
- wyjątkowo stabilny nawet przy silnym wietrze
- bardzo odporny na opady
- dwustronna prezentacja grafiki
- system clip-clap – szybka wymiana grafiki
- osłona na plakat z filtrem UV

Zestaw zawiera: potykacz Hampton, indywidualny karton.

Recommended media and printing technology for this system:



HAMPTON SILVER



A1	5907451662014	15 kg
A0	5907451663554	22 kg
B2	5907451663325	18 kg
B1	5907451663561	13 kg



HAMPTON BLACK



A1	5907451662199	15 kg
B2	5907451665756	13 kg



HAMPTON PRO

NEW!

- aluminium profile: 40 mm
- enhanced water resistance parameters
- base can be filled with water or sand
- handle and wheels for easy transport
- extremely stable even in strong wind
- double sided
- clip-clap system – quick graphics exchange
- thick poster cover with UV-filter protects the printout from fading colours

The set includes: stand Hampton Pro in a carton box.

- Aluminiumrahmen: 40 mm
- verbesserte Parameter für die Wasserbeständigkeit
- die Basis kann mit Wasser oder Sand gefüllt werden
- Griff und Räder für einfachen Transport
- extrem stabil auch bei starkem Wind
- doppelseitig
- System „clip-clap“ – sehr schneller Grafikaustausch
- Plakathülle mit UV-Filter schützt den Ausdruck vor dem Verblässen der Grafifarben

Das Set enthält: Kundenstopper Hampton Pro, Einzelkarton.

- profil aluminiowy: 40 mm
- zwiększona wytrzymałość na warunki atmosferyczne
- podstawa może być wypełniona wodą lub piaskiem
- wyjątkowo stabilny nawet przy silnym wietrze
- specjalna rączka i kółka ułatwiają przemieszczanie systemu
- dwustronna prezentacja grafiki
- system clip-clap – szybka wymiana grafiki
- osłona na plakat z filtrem UV

Zestaw zawiera: potykacz Hampton Pro, indywidualny karton.

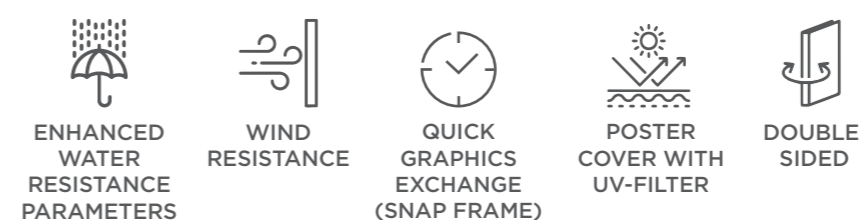

Recommended media and printing technology for this system:



HAMPTON PRO SILVER



A1	5907451666784	17 kg



HAMPTON PRO BLACK

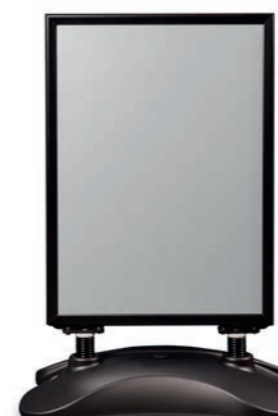

A1	5907451666791	17 kg



SEG

NEW!

- aluminium profile: 25 mm
 - fabric printout (SEG)
 - a practical handle allows it to be easily transported
- The set includes: SEG sidewalk sign (for self-assembly), individual carton box.



- Aluminiumrahmen: 25 mm
 - Stoffdruck (SEG)
 - praktischer Tragegriff
- Das Set enthält: SEG-Kundenstopper (zur Selbstmontage), Einzelkarton



- profil aluminiowy: 25 mm
 - wydruk na tkaninie (SEG)
 - praktyczna rączka ułatwia przenoszenie systemu
- Zestaw zawiera: potykacz SEG (do samodzielnego montażu), indywidualny karton.



Recommended media and printing technology for this system:



Fabric Sublimation printing



5907451660379



4,5 kg

INFO STAND CHROMA

- aluminium profile: 25 mm
 - double sided poster stand
 - ideal for use in various public spaces
 - easy installation of graphics via a sliding panel
 - stable construction
- This set includes: Info stand Chroma in individual box.

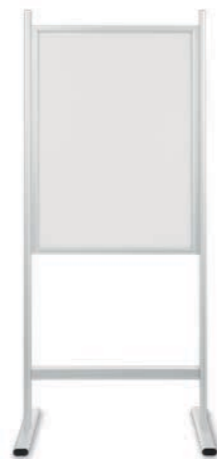

- Profilbreite (aluminium): 25 mm
 - doppelseitige Plakatständer
 - ideal für eine Vielzahl von öffentlichen Orten
 - einfache Montage von Grafiken über ein Einschub Brett
 - stabile Konstruktion
- Das Set enthält: Chroma Stand im Einzelkarton.



- profil aluminiowy: 25 mm
 - dwustronny stojak plakatu
 - idealnie sprawdzi się w różnych przestrzeniach publicznych
 - łatwy montaż grafiki poprzez wsunięcie jej w ramkę
 - stabilna konstrukcja
- Zestaw zawiera: stojak Info Chroma w indywidualnym kartonie.



5907451664414



5,50 kg

INFO/MENU STAND PULADI

- adjustable angle, transparent frame
 - stable steel base
 - exchange of graphics by sliding it into an acrylic frame
 - compact size when folded
 - product intended for directions and presenting information
- The set includes: Puladi stand, assembly kit with a hex key, individual box.



- verstellbarer, transparenter Rahmen
 - stabiler Stahlsockel
 - Austausch der Grafik durch Einschieben in einen Acrylrahmen
 - kompakte Größe im zusammengeklappten Zustand
 - Produkt, das u. a. zur Angabe von Richtungen und zur Darstellung von Informationen bestimmt ist
- Das Set enthält: einen Ständer Puladi, ein Montagesatz mit Inbus, Einzelkarton.



- regulowany kąt nachylenia ramy
 - przezroczysta ramka
 - stabilna, stalowa podstawa
 - wymiana grafiki poprzez wsunięcie jej w akrylową ramę
 - niewielkie rozmiary po złożeniu
 - produkt przeznaczony m. in do wskazywania kierunków oraz prezentacji informacji
- Zestaw zawiera: stojak Puladi, zestaw montażowy z imbussem, indywidualny karton..



	Barcode	Weight	Height
A4	6956526030080	2,2 kg	114 cm
A3	6956526030127	3,3 kg	120 cm

Recommended media and printing technology for this system:



INFO/MENU STAND CLASSIC

- **aluminium profile: 25 mm**
- base made of steel – very stable
- adjustable frame angle
- “clip-clap” system – quick graphics exchange
- compact size when folded

The set includes: stand Classic, assembly kit with a hex key, individual box.

- **Profilbreite (aluminium): 25 mm**
- Base aus Stahl - sehr stabil
- verstellbarer Rahmen
- System „clip-clap” – sehr schneller Grafikaustausch
- kompakte Größe im zusammengeklappten Zustand

Das Set enthält: einen Classic Ständer, ein Montagesatz mit Inbus, Einzelkarton.

- **ramka z aluminium: 25 mm**
- stabilna podstawa wykonana ze stali
- regulowany kąt nachylenia ramy
- błyskawiczna wymiana grafiki na zasadzie ramki zatraskowej OWZ
- niewielkie rozmiary po złożeniu

Zestaw zawiera: stojak Classic, zestaw montażowy z imbussem, indywidualny karton.



Recommended media and printing technology for this system:



A4	6956526030257	2,4 kg	111 cm
A3	6956526030264	3,5 kg	115 cm

INFO/MENU STAND STANDARD

- **aluminum profile: 25 mm**
- very elegant info stand
- designed, among others for restaurant menu, directions, presentation of information boards etc.
- clip-clap system – quick graphics exchange
- the frame can be positioned vertically or horizontally
- base made of iron

This set includes: stand Standard in a carton box.

- **Profilbreite (aluminium): 25 mm**
- sehr eleganter Informationsstand
- entworfen für Restaurantmenüs, Präsentation von Informationstafeln usw.
- System „clip-clap” – sehr schneller Grafikaustausch
- der Rahmen kann senkrecht oder waagrecht aufgestellt werden
- Base aus Eisen

Das Set enthält: einen Standard Ständer im Einzelkarton.

- **ramka aluminiowa: 25 mm**
- stabilna, żeliwna podstawa
- bardzo elegancki stojak informacyjny przeznaczony m.in. do menu restauracyjnego, prezentacji tabliczek informacyjnych itp.
- wymiana grafiki na zasadzie ramki zatraskowej OWZ
- możliwość ustawienia ramki w pionie lub poziomie

Zestaw zawiera: stojak Standard, indywidualny karton.



Recommended media and printing technology for this system:



A4	5907451662106	3,70 kg	116 cm
A3	5907451664322	4,30 kg	121 cm

INFO/MENU STAND PREMIUM

- **aluminium profile: 25 mm**
- base made of iron
- very elegant info stand
- designed, among others for restaurant menu, directions, presentation of information boards etc.
- clip-clap system – quick graphics exchange
- the frame can be positioned vertically or horizontally

This set includes: stand Premium stand in a carton box.

- **Profilbreite (aluminium): 25 mm**
- Base aus Eisen
- sehr eleganter Informationsstand entworfen für Restaurantmenüs, Präsentation von Informationstafeln usw.
- System „clip-clap” – sehr schneller Grafikaustausch
- der Rahmen kann senkrecht oder waagrecht aufgestellt werden

Das Set enthält: einen Premium Ständer im Einzelkarton.

- **alumiowa ramka: 25 mm**
- stabilna, żeliwna podstawa
- bardzo elegancki stojak informacyjny
- system przeznaczony m. in. do menu restauracyjnego, prezentacji tabliczek informacyjnych itp.
- wymiana grafiki na zasadzie ramki zatraskowej OWZ
- możliwość ustawienia ramki w pionie lub poziomie

Zestaw zawiera: stojak Premium, indywidualny karton.

Recommended media and printing technology for this system:



PREMIUM SILVER



A3	5907451664407	4,70 kg	126 cm
A2	5907451664391	5,00 kg	140 cm

PREMIUM BLACK



A4	5907451667590	4 kg	125 cm
A3	5907451664438	4,70 kg	126 cm
A2	5907451664421	5,00 kg	140 cm

METAL EASEL

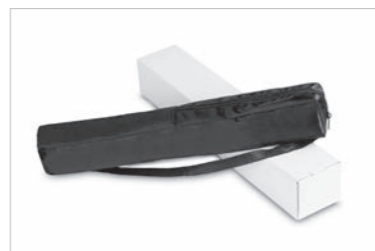

- made of black powder painted metal
 - small size after folding
 - elegant case included
- The set includes: easel, transport case.

- aus schwarz pulverlackiertem Metall
 - kleine Größe nach dem Zusammenklappen
 - eleganter Koffer inklusive
- Das Set enthält: Staffelei, Transportkoffer.

- sztaluga z metalu pomalowanego proszkowo
 - niewielkie rozmiary po złożeniu
 - elegancka torba w zestawie
- Zestaw zawiera: sztalugę, torbę transportową.



5907451663578



1,2 kg



WOODEN PRODUCTS

CHALKBOARD SIGNS CLASSIC

- profile: 35 mm
- elegant wooden frame
- versatile design-will fit into any space
- writing surface made of chalkboard
- ideal for restaurants and retail spaces

- Profilbreite: 35 mm
- eleganter Holzrahmen
- universelles Aussehen-passt zu jedem Raum
- schreibfläche aus Kreidebrett
- ideal für Restaurants und Einkaufsmöglichkeiten

- profil: 35 mm
- elegancka, drewniana rama
- powierzchnia do pisania - tablica kredowa
- idealne rozwiązanie dla restauracji czy innych powierzchni

CLASSIC

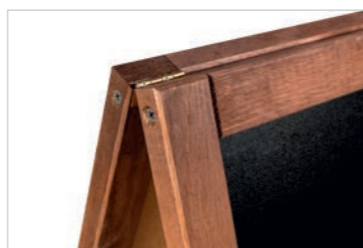

S	51×90 cm	5907451669808	3,5 kg
M	60×100 cm	5907451664780	4 kg
L	61×118 cm	5907451669785	5,5 kg
XL	72×160 cm	5907451669778	9 kg

CLASSIC NATURAL

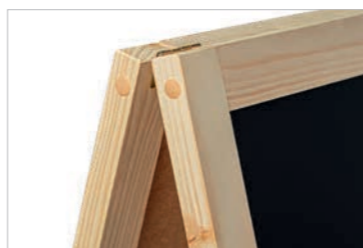

S	51×90 cm	5907451667484	3,5 kg
M	60×100 cm	5907451667347	4 kg
L	61×118 cm	5907451668535	5,5 kg
XL	72×160 cm	5907451667491	9 kg

CLASSIC RED

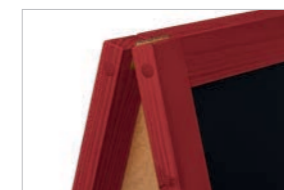
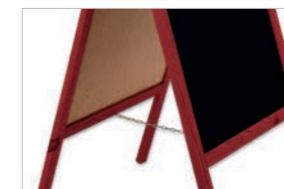

S	51×90 cm	5907451667736	3,5 kg
M	60×100 cm	5907451667743	3,5 kg
L	61×118 cm	5907451667750	5,5 kg
XL	72×160 cm	5907451667767	9 kg

CLASSIC BLACK

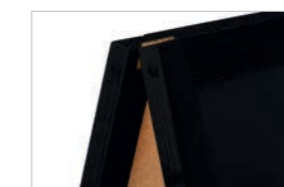
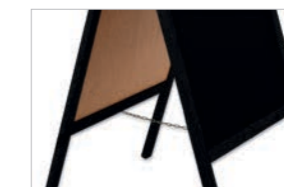

S	51×90 cm	5907451667668	3,5 kg
M	60×100 cm	5907451667330	3,5 kg
L	61×118 cm	5907451667651	5,5 kg
XL	72×160 cm	5907451667729	9 kg

CLASSIC GREEN

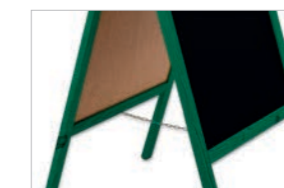

S	51×90 cm	5907451668269	3,5 kg
M	60×100 cm	5907451668276	3,5 kg
L	61×118 cm	5907451668283	5,5 kg
XL	72×160 cm	5907451668290	9 kg

CHALKBOARD SIGN PRO WATERPROOF

- profile: 60 mm**
 - weather resistant due to varnish coating
 - very durable construction
 - stability ensured by the weight - 21 kg
 - silver chain securing the legs
- Profilbreite: 60 mm**
 - witterungsbeständig durch Lackbeschichtung
 - sehr langlebige Konstruktion
 - stabilität gewährleistet durch das Gewicht - 21 kg
 - silberkette zur Sicherung der Beine
- profil: 60 mm**
 - wytrzymałość na warunki atmosferyczne dzięki lakierowanej powierzchni
 - bardzo trwała konstrukcja
 - stabilny produkt o wadze 21 kg
 - łańcuszek zabezpieczający rozstawienie nóg potykacza



LIQUID CHALK MARKERS

- A set of 8 markers with liquid chalk for chalkboard writing. A perfect replacement for dusty chalk. The set consists of 8 markers in following vivid colours: white, yellow, orange, pink, red, light blue, violet, green. The markers have a dual, reversible chisel: round and flat. This enables writing in bold. Markers are non-toxic, unscented, and easily removed with water.
- Ein Satz von 8 Markern mit flüssiger Kreide zum Schreiben an die Tafel. Ein perfekter Ersatz für staubige Kreide. Das Set besteht aus 8 Markern in folgenden leuchtenden Farben: weiß, gelb, orange, pink, rot, hellblau, violett, grün. Die Marker haben einen doppelten, umkehrbaren Meißel: rund und flach. Dies ermöglicht Fettschrift. Marker sind ungiftig, geruchlos und leicht mit Wasser zu entfernen.
- Zestaw 8 markerów z płynną kredą do pisania na tablicach kredowych. Doskonała alternatywa dla pyłacej, tradycyjnej kredy. W zestawie 8 markerów w „żywych” kolorach: biały, żółty, pomarańczowy, różowy, czerwony, błękitny, fioletowy, zielony. Każdy marker posiada dwustronną końcówkę: okrągłą oraz płaską. Daje to możliwość pisania linią o różnych szerokościach. Markery są bezzapachowe i nietoksyczne oraz łatwo zmywalne przy pomocy wody.



5907451665480

CHALKBOARDS

KREIDETAFELN

TABLICE KREDOWE



- Classic chalkboards in wooden frames. **The frame profile is 3,5 cm.** The writing, black space is made of solid, durable HDF board. Chalk and liquid chalk markers can be used for writing on the HDF board. The chalkboards can be presented vertically and horizontally.
- Klassische Tafeln in Holzrahmen. **Das Rahmenprofil beträgt 3,5 cm.** Die schreibende, schwarze Fläche ist aus massiver, strapazierfähiger HDF-Platte. Zum Beschriften der HDF-Platte können Kreide - und Flüssigkredemarker verwendet werden. Die Tafeln können vertikal und horizontal präsentiert werden.
- Klasyczne tablice z powierzchnią kredową w drewnianej ramie. **Ramy tablic kredowych mają szerokość 3,5 cm.** Powierzchnia do pisania wykonana jest z twardej i wytrzymałej płyty HDF. Można po niej pisać kredą lub markerem kredowym. Możliwość wieszania w pionie i poziomie lub eksponowania na sztaludze.



Frame size	Blackboard size		
47x60 cm	40x53 cm	5907451669686	1,5 kg
47x79 cm	40x72 cm	5907451669679	1,8 kg
60x87 cm	53x80 cm	5907451669662	2,1 kg
80x100 cm	73x93 cm	5907451669655	3 kg

TABLE STANDS

TISCHAUFSTELLER

STOJAKI KREDOWE



- Double sided tabletop chalkboards in 3 sizes. The bottom is a brown wooden panel. Classic, plain look ensures fine presenting the stand in various spaces. The black board is made of durable HDF plate, that makes it possible to write with chalk or liquid chalk markers on it.
- Doppelseitige Tafel tafeln in 3 Größen. Der Boden ist eine braune Holzplatte. Klassische, schlichte Optik sorgt für eine feine Präsentation des Standes in verschiedenen Räumen. Die schwarze Tafel besteht aus strapazierfähiger HDF-Platte, die es ermöglicht, mit Kreide oder flüssigen Kreidemarkern darauf zu schreiben.
- Tabliczki kredowe dwustronne w 3 rozmiarach. Tabliczki mają drewnianą podstawę w kolorze brązowym. Prosty, klasyczny wygląd stojaków pozwala na ich zastosowanie w wielu przestrzeniach. Powierzchnia do pisania została wykonana z trwałej płyty HDF, po której można pisać kredą lub dającymi doskonały efekt markerami kredowymi.



	Blackboard size	
A6	10x15 cm	5907451669624
A5	15x21 cm	5907451669631
A4	21x30 cm	5907451669648

EASEL

 A wooden easel will be perfect as a display in stores, galleries or restaurants. Classic look and stable construction are the distinctive features of this product. The easel has an adjustable tilt angle. The bottom shelf and upper handle ensure reliable hold of the frame or picture.

 Die Staffelei aus Holz ist perfekt als Präsentation in Läden, Galerien oder Restaurants. Klassisches Aussehen und stabile Konstruktion sind die besonderen Merkmale dieses Produkts. Die Staffelei hat einen einstellbaren Neigungswinkel. Die untere Ablage und der obere Griff sorgen für einen zuverlässigen Halt eines Rahmens oder eines Bildes.

 Drewniana sztaluga sprawdzi się jako elegancki ekspozytor w sklepach, galeriach czy restauracjach. Klasyczny wygląd i stabilna konstrukcja to główne cechy tego produktu. Sztaluga posiada regulowany kąt nachylenia. Półka dolna oraz górny uchwyt zapewniają pewne trzymanie ramy lub obrazu.

EASEL NATURAL



5907451669716

Chalkboard not included

EASEL MAHOGANY



5907451669143

Chalkboard not included

EASEL WHITE



5907451668979

Chalkboard not included

EASEL BLACK



5907451668986

Chalkboard not included



LOUNGERS

WOODEN LOUNGER

(4 PIECES OR FOR SELF-ASSEMBLY)



- sturdy pine construction
- 3-stage backrest adjustment
- high load capacity (120 kg)
- special locking elements prevent the lounger from uncontrolled folding

The product meets PN-EN 581-1:2017-04 oraz PN-EN 581 1-2:2016-02 requirements.

- robuste Kieferkonstruktion
- 3-stufige Rückenlehnenverstellung
- Belastbarkeit von bis zu 120 kg
- spezielle Verriegelungselemente verhindern ein unkontrolliertes Zusammenklappen der Liege

Das Produkt erfüllt die Anforderungen von PN-EN 581-1:2017-04 und PN-EN 581 1-2:2016-02.

- solidna konstrukcja, drewno sosnowe
 - 3 stopnie regulacji oparcia
 - wysoka wytrzymałość (do 120 kg)
 - specjalne blokady zapobiegają przed przypadkowym złożeniem leżaka
- Produkt spełnia normy PN-EN 581-1:2017-04 oraz PN-EN 581 1-2:2016-02.



Lounger material not included



4 pieces	5907451668788	2,5 kg / 1 piece
self-assembly	5907451668795	2,5 kg

ALUMINIUM LOUNGER

NEW!

- 4-stage backrest adjustment
 - high load capacity to 130 kg
 - solid, aluminium construction
- The set includes: lounger, individual carton box.

- 4-stufige Rückenlehnenverstellung
 - Belastbarkeit von bis zu 120 kg
 - Aluminium-Konstruktion
- Das Set enthält: Liegestuhl, Einzelkarton.

- 4 stopniowa regulacja oparcia
 - wytrzymałość do 130 kg
 - aluminiowa konstrukcja
- Zestaw zawiera: leżak, indywidualny karton.



Lounger material not included



	5907451660386	3,2 kg



QUEUE BARRIER

PREMIUM BARRIER

High quality barrier posts with a tape winding system. The post weight was raised to 7.5 kg, and the tape extended to 225 cm. The winding head is integrated with the post, and its replacement is very simple and quick. The tape used in the head is a car seat belt, extremely strong and durable (red colour - exchangeable).

Hochwertige Absperrpfosten mit Bandwickelsystem. Das Pfostengewicht wurde auf 7,5 kg erhöht und das Band auf 225 cm verlängert. Der Wickelkopf ist in den Pfosten integriert und kann sehr einfach und schnell ausgetauscht werden. Das im Kopf verwendete Klebeband ist ein Autositzgurt, extrem stark und langlebig (rote Farbe - austauschbar).

Wysokiej jakości słupki odgradzające z automatem do zwijania taśmy. Waga słupka została podniesiona do 7,5 kg, a taśma wydłużona do 225 cm. Głowica nawijająca jest zintegrowana ze słupkiem, a jej wymiana jest bardzo prosta i szybka. Taśma zastosowana w głowicy to samochodowy pas bezpieczeństwa, niezwykle mocny i trwały (kolor czerwony - wymienny).

HOTEL BARRIER

Hotel barrier well known in many markets in the two most popular colors: gold and silver. Extremely stable, high quality. It will not only be a system to control people, but also an interior decoration for restaurants, clubs or hotels.

Hotelbarriere in vielen Märkten in den beiden beliebtesten Farben bekannt: Gold und Silber. Extrem stabil, hohe Qualität. Es wird nicht nur ein System zur Kontrolle von Menschen sein, sondern auch eine Innenausstattung für Restaurants, Clubs oder Hotels.

Bariera hotelowa znana na wielu rynkach w dwóch najpopularniejszych kolorach: złotym i srebrnym. Niezwykle stabilna, wysoka jakość. Będzie to nie tylko system sterowania ludźmi, ale także dekoracja wnętrz restauracji, klubów czy hoteli.



PREMIUM BLACK



PREMIUM CHROME



ROYAL CHROME

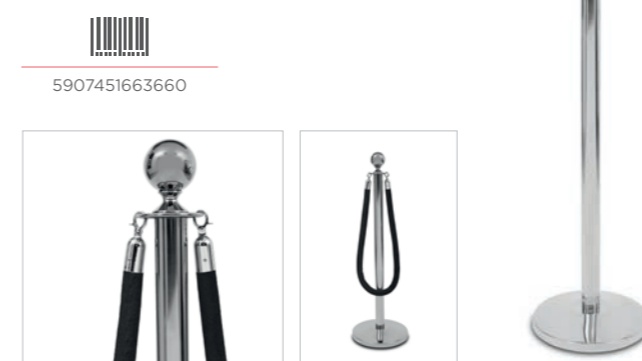

MODERN CHROME

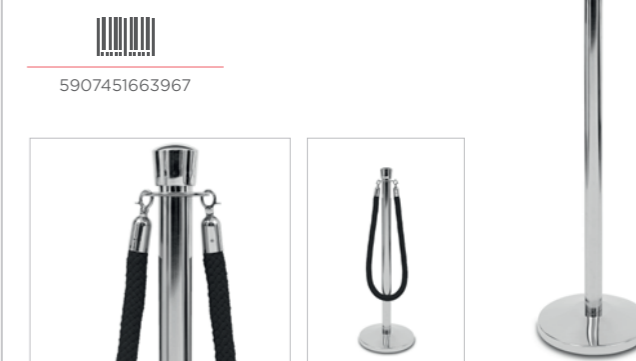

ROYAL GOLD

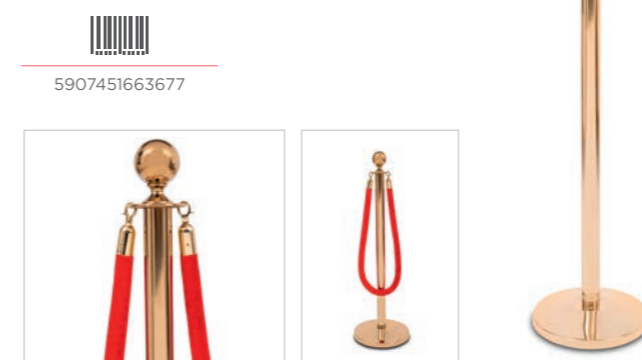

MODERN GOLD

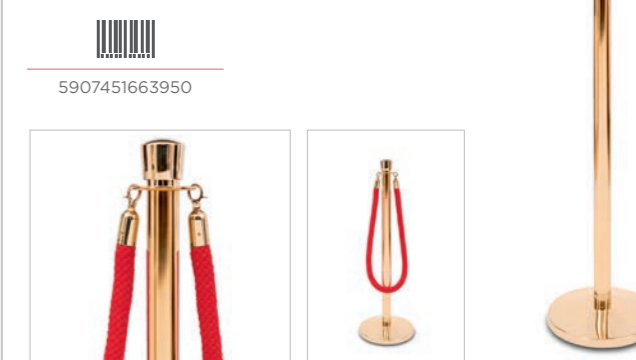

PREMIUM WHITE



REPLACEMENT HEADS

AUSTAUSCHKÖPFE
GŁOWICE WYMIENNE
DO SŁUPKÓW



VELVET BORDER

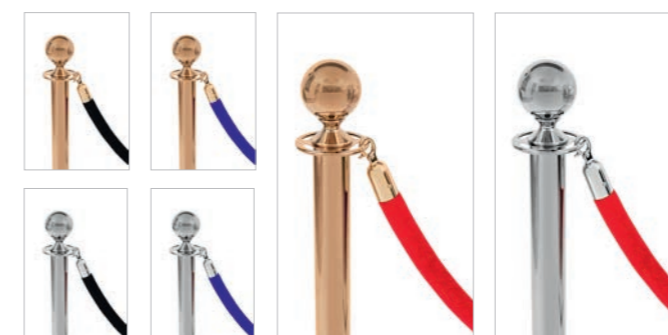

LACED BORDER





Borders available with silver or gold claps.
Band mit Silber - oder Goldriegel erhältlich.
Bordery dostępne ze srebrnymi lub złotymi klamrami.

BARRIER POST INFO FRAME

ABSPERRPFOSTEN INFORMATIONSRAHMEN
RAMKI INFORMACYJNE NA SŁUPKI

 Double-sided A4 information frame applied on the top of barrier post. Available in two colors: chrome and black mat.

 Doppelseitiger A4-Informationsrahmen, der oben auf dem Absperrpfosten angebracht ist. Erhältlich in zwei Farben.

 Ramka informacyjna A4 dwustronna, umieszczona na szczycie słupka.

INFO FRAME CHROME



5907451662403

INFO FRAME BLACK



5907451662397

WALL MOUNTED HEAD

WANDBASE
GŁOWICA NAŚCIENNA

 A belt in another colour is available by purchasing a replacement head in our store.

 Das Band kann durch den Kauf eines Ersatzkopfes in unserem Shop gegen andere Farben ausgetauscht werden.

 Taśmę wymienić można na inne kolory, zakupując głowicę zamienną w naszym sklepie.



black 5907451665053

red 5907451663318



FLAG POLES

STANDARD POLE

One pole many shapes:
(Example shapes)



- one pole - many shapes
- low cost pole
- quick assembly
- aluminium + fiberglass
- fits to all types of our bases

This set includes: Standard pole and taffeta sack.

- ein Mast-mehrere Formen
- niedriger Preis
- schnelle Installation
- aluminium + fiberglas
- geeignet für alle Arten von Grundlagen

Das Set enthält: Standard Mast und polyester Tasche.

- jeden maszt - wiele kształtów
- niska cena
- szybki montaż
- aluminium + włókno szklane
- pasuje do wszystkich typów naszych podstaw

Zestaw zawiera: maszt Standard i worek poliesterowy.

S	5907451662298	0,40 kg	290 cm
M	5907451662304	0,50 kg	350 cm
L	5907451662311	0,60 kg	450 cm
XL	5907451662328	0,80 kg	550 cm

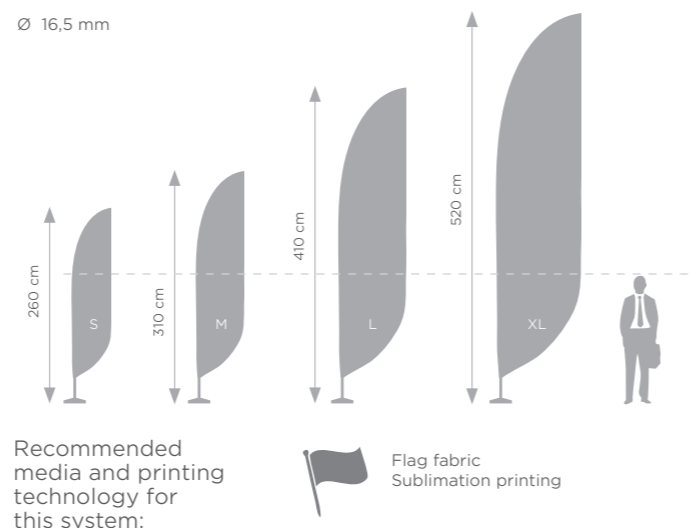
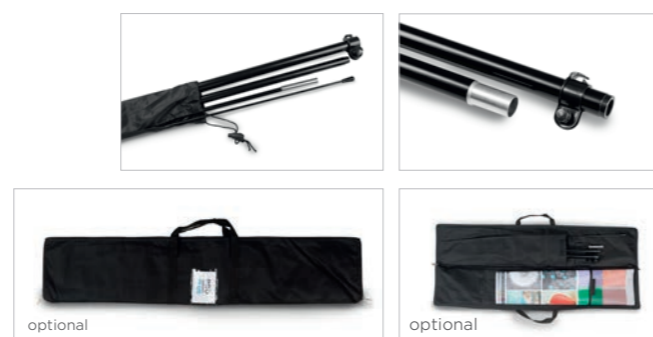

STANDARD PLUS POLE

One pole many shapes:
(Example shapes)



FULL FIBERGLASS



STRENGTH AND DURABILITY

- full fiberglass
- one pole - many shapes
- quick assembly
- fits to all types of our bases

This set includes: Standard Plus pole, a polyester bag.

- ein Mast-mehrere Formen
- niedriger Preis
- schnelle Installation
- komplett aus Fiberglas
- geeignet für alle Arten von Grundlagen

Das Set enthält: Standard Plus Mast und polyester Tasche.

- jeden maszt - wiele kształtów
- niska cena
- szybki montaż
- włókno szklane
- pasuje do wszystkich typów naszych podstaw

Zestaw zawiera: maszt Standard Plus i worek poliesterowy.

S	5904423600654	0,40 kg	290 cm
M	5904423600661	0,50 kg	340 cm
L	5904423600678	0,60 kg	450 cm
XL	5904423600685	0,80 kg	550 cm

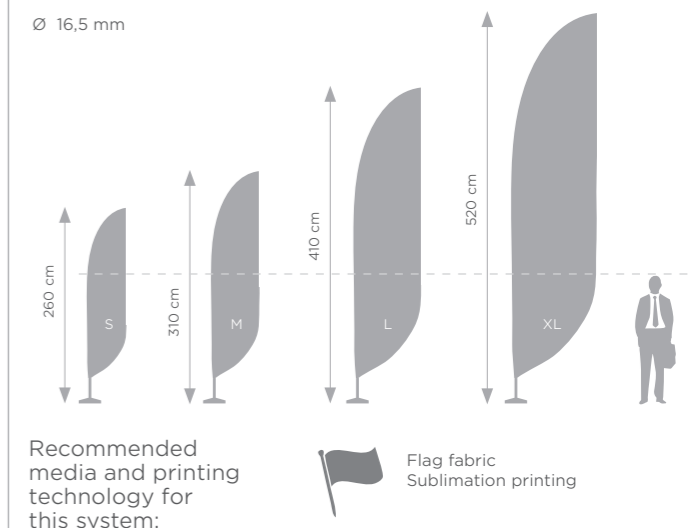
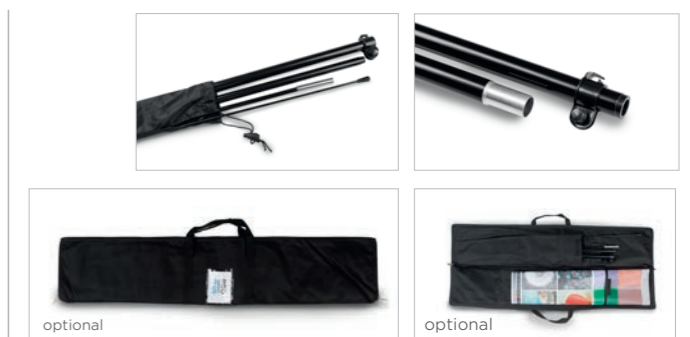

PRO POLE

One pole many shapes:
(Example shapes)



FULL FIBERGLASS



STRENGTH
AND DURABILITY

- one pole - many shapes
- mast made entirely of fiberglass
- high quality
- quick assembly
- fits to all types of our bases

This set includes: PRO pole and taffeta sack.

- ein Mast-mehrere Formen
- komplett aus Fiberglas
- hohe Qualität
- schnelle Installation
- geeignet für alle Arten von Grundlagen

Das Set enthält: PRO mast und polyester Tasche.

- jeden maszt - wiele kształtów
- maszt w całości wykonany z włókna szklanego
- wysoka jakość produktu
- szybki montaż
- pasuje do wszystkich typów naszych podstaw

Zestaw zawiera: maszt PRO i worek poliestrowy.

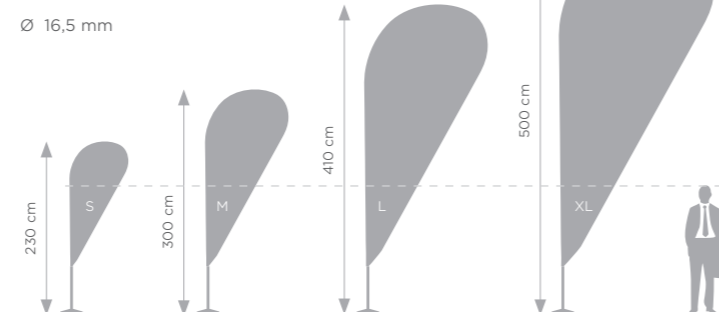
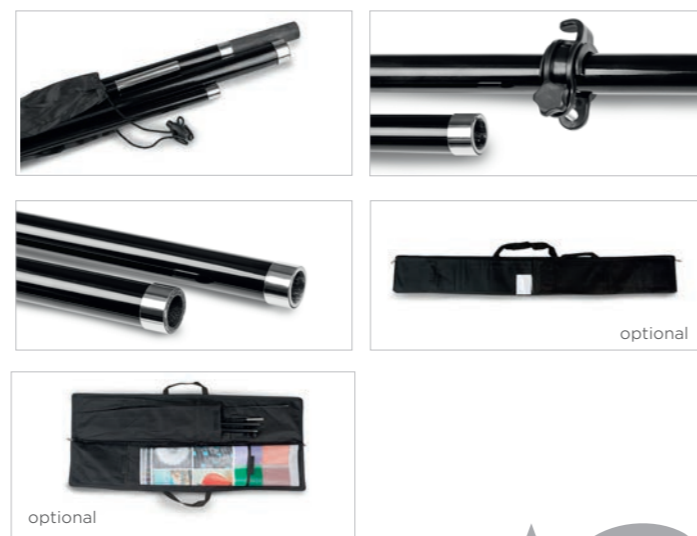

Recommended media and printing technology for this system:



	Barcode	Weight	Height
S	5907451662335	0,50 kg	290 cm
M	5907451662342	0,60 kg	340 cm
L	5907451662359	0,70 kg	450 cm
XL	5907451662366	0,95 kg	560 cm

H POLES

- large advertising space
- even in the absence of wind
- quick and easy assembly
- fits to all kinds of our bases
- full aluminium

This set includes: H pole and taffeta sack.

- große Werbebereich
- auch in abwesenheit von wind
- schnelle und einfache Installation
- geeignet für alle Arten von Grundlagen
- komplett aus Aluminium

Das Set enthält: H mast und polyester Tasche.

- duża powierzchnia reklamowa
- sprawdzi się nawet przy braku wiatru
- szybki i prosty montaż
- pasuje do wszystkich typów podstaw
- w całości wykonany z aluminium

Zestaw zawiera: maszt H i worek poliestrowy.

Recommended media and printing technology for this system:

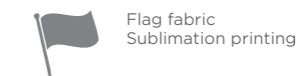

	Barcode	Weight
S	5907451663271	0,80 kg
M	5907451662441	0,90 kg
L	5907451663288	1,20 kg

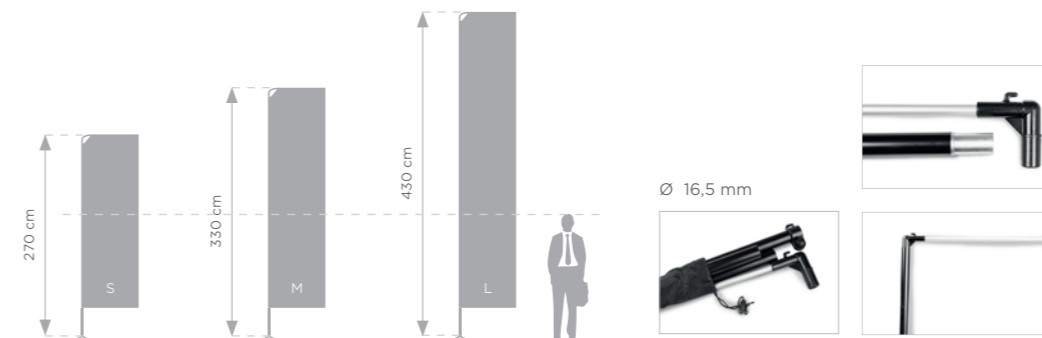

AVENUE

Great for parking in shopping centers, car dealerships, alleys and city promenades. This set includes: upper and lower double pole, clamps, rubber pads, zips to protect flag/banner.

Ideal für Parkplätzen von Einkaufszentren, Autohäusern, Gassen und städtischen Fußgängerzonen. Dieses Set enthält: Oberer und unterer Mast, Klemmen, Gummipuffer, Kabelbinder.

Świetnie sprawdzi się na parkingach centrów handlowych, salonach samochodowych, alejach i deptakach miejskich. Zestaw zawiera: stalową bazę górną i dolną belkę w kolorze białym, gumowe podkładki i opaski.

Recommended media and printing technology for this system:

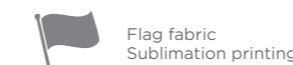

	Barcode	Height
Single sided	5907451663523	66 cm
Double sided	5907451663530	66 cm
Single sided	5907451667705	80 cm
Double sided	5907451667712	80 cm

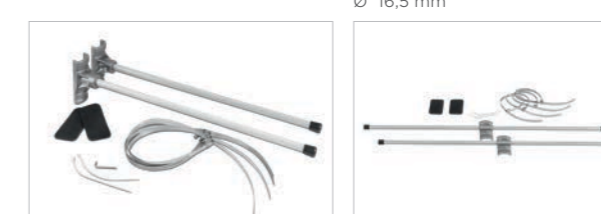

TUBE FEATHER FLAGPOLE

NEW!

- exceptionally strong construction
- entirely of aluminium
- flag pole compatible with all bases in our product range
- available in a string bag or zip bag

The set includes: tube flag pole feather, string bag/zip bag.

- außergewöhnlich stabile Konstruktion
- komplett aus Aluminium
- Fahnenmast kompatibel mit allen Sockeln aus unserem Sortiment
- erhältlich in Polyestersack oder Tragetasche

Das Set enthält: einen Mast Feder, einen Polyestersack/Tragetasche.

- wyjątkowo mocna konstrukcja
- maszt w całości z aluminium
- produkt kompatybilny z podstawami dostępnymi w naszej ofercie
- dostępny w worku poliestrowym lub torbie z długim zamknięciem

Zestaw zawiera: maszt Pióro, worek poliestrowy/torbę transportową.



S (string bag)	5907451665930	0,70 kg	265 cm
M (string bag)	5907451665947	0,90 kg	340 cm
L (string bag)	5907451665954	1,15 kg	435 cm
S (zip bag)	5907451665497	0,70 kg	265 cm
M (zip bag)	5907451665503	0,90 kg	340 cm
L (zip bag)	5907451665510	1,15 kg	435 cm

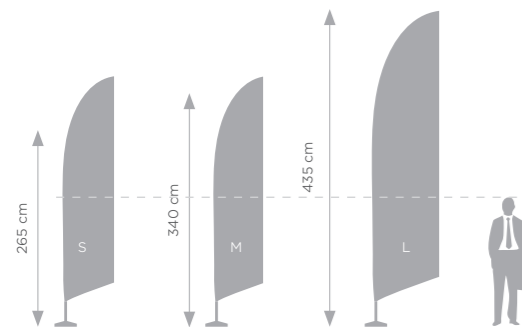

Ø 16,5 mm

Recommended media and printing technology for this system:



TUBE H FLAGPOLE

NEW!

- exceptionally strong construction
- entirely of aluminium
- flag pole compatible with all bases in our product range
- available in a string bag or zip bag

The set includes: tube flag pole H, string bag/zip bag.

- außergewöhnlich stabile Konstruktion
- komplett aus Aluminium
- Fahnenmast kompatibel mit allen Sockeln aus unserem Sortiment
- erhältlich in Polyestersack oder Tragetasche

Das Set enthält: einen H Mast, einen Polyestersack/Tragetasche.

- wyjątkowo mocna konstrukcja
- maszt w całości z aluminium
- produkt kompatybilny z podstawami dostępnymi w naszej ofercie
- dostępny w worku poliestrowym lub torbie z długim zamknięciem

Zestaw zawiera: maszt H, worek poliestrowy/torbę transportową.

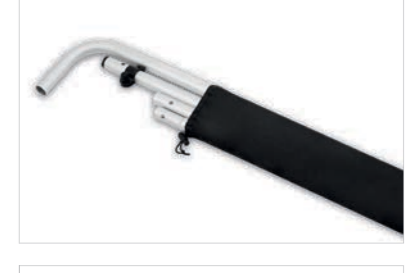

S (string bag)	5907451667774	1,1 kg	305 cm
M (string bag)	5907451667781	1,3 kg	375 cm
L (string bag)	5907451667798	1,4 kg	415 cm
S (zip bag)	5907451665527	1,1 kg	305 cm
M (zip bag)	5907451665534	1,3 kg	375 cm
L (zip bag)	5907451665541	1,4 kg	415 cm

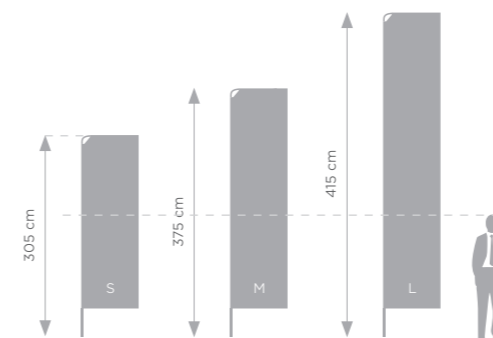

Ø 16,5 mm

Recommended media and printing technology for this system:



POLE BASE

PLATE

PLATTE
PŁYTA

- square plate made of heavy cast iron
- perfect base and stabilization for every flag
- base mounted to the ground using pins
- hollow handle makes it easy to carry
- schwere Gusseisen quadratische Platte
- perfekte Basis und Stabilisierung für jede Flagge
- die Basis wird mit Stiften auf den Boden montiert
- Griff für den einfachen Transport
- kwadratowa płyta wykonana z ciężkiego żeliwa
- idealna baza i stabilizacja dla każdej flagi
- baza montowana do podłoża za pomocą szpilek
- wydrążona rączka ułatwia przenoszenie



RUBBER FEETS
OPTIONAL

Weight	Barcode	Dimensions
4 kg	5907451661765	30x30 cm
6 kg	5907451661772	35x35 cm
8 kg	5907451661789	39x39 cm
12 kg	5907451661796	48x48 cm

Pin Ø 16,5 mm

RUBBER BASE WITH ROTATOR

NEW!

GUMMIBASIS MIT ROTATOR
PODSTAWA GUMOWA Z ROTATOREM

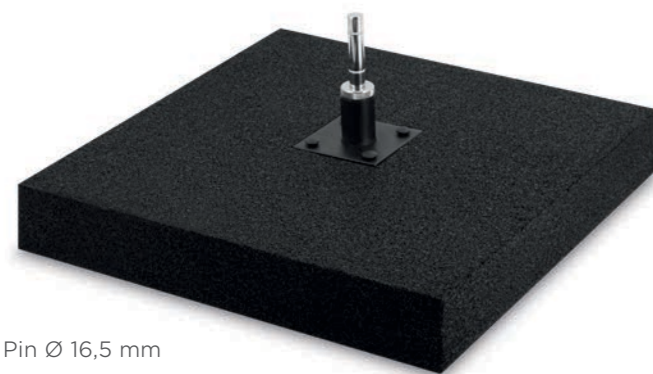

Pin Ø 16,5 mm

- very heavy rubber base with stainless steel rotator
- the rotator is compatible with all flag poles in our offer
- sehr schwerer Gummifuß mit Rotator aus Edelstahl
- der Rotator passt zu allen in unserem Angebot erhältlichen Masten
- bardzo ciężka gumowa podstawa z rotatorem ze stali nierdzewnej
- rotator pasuje do wszystkich masztów dostępnych w naszej ofercie

Barcode	Weight
5904423600821	10 kg
5904423601071	12 kg
5904423600838	15 kg
5907451664803	19 kg

TWISTER



Pin Ø 16,5 mm

- An accessory that allows you to create a unique advertising medium using two poles.
- Ein Zubehörteil, mit dem Sie ein einzigartiges Werbemedium aus zwei Masten erstellen können.
- Akcesorium, które pozwala na stworzenie unikalnej reklamy z użyciem 2 masztów.

Barcode	Weight
5907451662410	0,8 kg

FLAT CROSS

FLACHE KREUZ
KRZYŻAK PŁASKI

- for use on flat and soft grounds
- can be attached to the ground with pins
- can be additionally loaded with a water bag

- für den Einsatz auf flachem und weichem Untergrund
- kann mit Stiften am Boden befestigt werden
- kann zusätzlich belastet sein mit Wasserbeutel

- do użytkowania na podłożu płaskim i miękkim
- może być przytwierdzona do podłoża za pomocą szpilek
- może być dodatkowo obciążona sakwą wodną



Barcode	Weight	Dimensions	Pin
5907451661857	2,3 kg	60x53 cm	Pin Ø 16,5 mm

TUBE CROSS

ROHRE KREUZ
KRZYŻAK RURKI

- elegant base designed mainly for indoor interiors
- can be additionally loaded with a water bag

- elegante Basis, vor allem für den Innenraum
- kann zusätzlich belastet sein mit Wasserbeutel

- elegancka podstawa przeznaczona głównie do wnętrz
- może być dodatkowo obciążona sakwą wodną

TUBE CROSS GREY



Barcode	Weight	Dimensions	Pin
5907451661864	1,4 kg	82x70 cm	Pin Ø 16,5 mm

TUBE CROSS BLACK



Barcode	Weight	Dimensions	Pin
5907451669044	1,4 kg	82x70 cm	Pin Ø 16,5 mm

WATER BAG

WASSERBEUTEL
SAKWA WODNA

- additional load
- after filled with water, it reaches a weight of up to 10 kg
- particularly suitable for high poles.

- zusätzliche Belastung für die Grundlagen
- beim Füllen mit Wasser erreicht ein Gewicht von bis zu 10 kg
- besonders geeignet für hohe Masten

- dodatkowe obciążenie podstaw
- po napełnieniu wodą osiąga wagę nawet 10 kg
- sprawdza się w szczególności w przypadku wysokich masztów



Barcode	Weight	Dimensions
5907451661871	0,5 kg	Ø 50 cm

Ø 50 mm



POLE BASE

WATER TANK

WASSERKANISTER
KONTENER WODNY

- bestseller
 - made of thick plastic with a terminal hole for the mast
 - after filled with water, it can weigh up to 20 kg
- Bestseller
 - aus dickem Kunststoff mit Klemmloch für Mast
 - wenn es mit Wasser gefüllt ist, kann es bis zu 20 kg wiegen
- bestseller
 - wykonany z grubego plastiku z otworem zaciskowym na maszt
 - po napełnieniu wodą może ważyć nawet do 20 kg

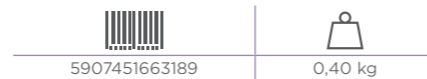

WATER TANK WITH ROTATOR

NEW!

- made of thick, flexible plastic
 - stainless steel rotator
 - after filled with water, it can weigh up to 20 kg
- Wassertank mit Rotator aus Edelstahl
 - aus dickem, flexiblem Kunststoff
 - wenn es mit Wasser gefüllt ist, kann es bis zu 20 kg wiegen
- kontener wodny z rotatorem ze stali nierdzewnej
 - produkt z grubego plastiku
 - po napełnieniu wodą może ważyć nawet do 20 kg



Pin Ø 16,5 mm



WATER TANK WITH PIN

NEW!

- made of thick, flexible plastic
 - stainless steel pin
 - after filled with water, it can weigh up to 20 kg
- Wassertank mit Bolzen aus Edelstahl
 - aus dickem, flexiblem Kunststoff
 - wenn es mit Wasser gefüllt ist, kann es bis zu 20 kg wiegen
- kontener wodny z trzpieniem ze stali nierdzewnej
 - produkt z grubego plastiku
 - po napełnieniu wodą może ważyć nawet do 20 kg



Pin Ø 16,5 mm



CARBASE

AUTOBASE
AUTOBAZA

- metal base designed for salons and car stores
 - mounted under the car wheel
 - optionally a rotator can be used
- metallbasis für Autohäuser
 - es ist eine Luftwaffenbasis, unter Rädern von Autos
 - rotator kann optional angewendet werden
- metalowa podstawa przeznaczona dla salonów i komisów samochodowych
 - baza najazdowa, pod koło samochodowe
 - opcjonalnie można zastosować rotator



Pin Ø 16,5 mm

BAYONET SINGLE OR DOUBLE

BAJONETT EINFACHER ODER DOPPELTER
BAGNET POJEDYNCZY LUB PODWÓJNY

BEST SELLER

- bestseller
 - designed for fixing poles to soft grounds
 - made of stainless steel
 - equipped with a rotator
- Bestseller
 - um Masten an weichen Boden zu befestigen
 - aus Edelstahl gefertigt
 - ausgestattet mit rotator
- bestseller
 - przeznaczony do mocowania masztów do miękkiego podłoża
 - wykonany ze stali nierdzewnej
 - wyposażony w rotator

single	5907451661888	0,95 kg
double	5907451661895	1,25kg

Rotator Ø 16,5 mm



DRILL

DRILL
DRYL

- perfect for fastening poles to grass and sand
 - it has practical, folding handles that help screw the base to the ground
 - made of plastic, includes a rotator
- geeignet für die Befestigung von Masten an grasbewachsenen und sandigen Flächen
 - es hat praktische Klappgriffe, die helfen, die Basis auf den Boden zu befestigen
 - aus Kunststoff, hat einen Rotator
- sprawdzi się do mocowania masztów do powierzchni trawiastych i piaskowych
 - posiada praktyczne, rozkładane rączki, które pomogą przykręcić podstawę do podłoża
 - wykonany z tworzywa sztucznego
 - posiada rotator



Rotator Ø 16,5 mm



ROTATORS

ROTATOR 90°

- 🇬🇧
 - integrated with a cast iron plate
 - ability to attach the base to a hard surface
 - set does not include dowels and fastening screws
- 🇩🇪
 - integriert mit gusseisen platte
 - möglichkeit der Befestigung der Basis an festem Boden
 - nicht enthalten dübel und Befestigungsschrauben
- 🇵🇱
 - zintegrowany z żeliwną płytką
 - możliwość przymocowania podstawy do twardego podłoża
 - zestaw nie zawiera kołków i śrub mocujących



5907451661932



0,80 kg

ROTATOR 45°

- 🇬🇧
 - used for attaching the poles to the wall
 - the set does not include dowels and fastening screws
- 🇩🇪
 - wird verwendet, um Masten an der Wand zu befestigen
 - Dübel und Befestigungsschrauben sind nicht enthalten
- 🇵🇱
 - służy do mocowania masztów do ściany
 - zestaw nie zawiera kołków i śrub mocujących



5907451661949



0,80 kg

ROTATOR

- 🇬🇧
 - made of stainless steel
 - a great replacement for standard mandrels used in such bases as: plate, flat cross, auto base
 - allows free rotation of the mast in accordance with the direction of the wind
- 🇩🇪
 - aus Edelstahl gefertigt
 - ausgezeichneter ersatz für standard-Dorn in basen wie: Platte, Kreuz, Auto basis
 - ermöglicht es dem Mast, sich frei entsprechend der Windrichtung zu drehen
- 🇵🇱
 - wykonany ze stali nierdzewnej
 - świetne zastępstwo do standardowych trzpieni w takich podstawach jak: płyty, krzyżak płaski, auto baza
 - pozwala na swobodne obracanie się masztu zgodnie z kierunkiem wiatru



Ø 16,5 mm



5907451661840



0,45 kg



TENT FRAMES

ZELTRAHMEN
STELAŻ NAMIOTÓW





- tent racks made of two types of materials: steel or aluminium
 - several sizes available
 - Everest - lightweight design, ideal for frequent change of location
 - Blanc - heavy, durable construction, powder coated white
- The set includes: foldable tent frame, mounting accessories, trolley bag.

- Zelte aus zwei Arten von Materialien: Stahl oder Aluminium
- viele Größen verfügbar
- Everest - leichteres Design, ideal für häufige Standortwechsel
- Blanc - schwere, stabile Konstruktion, pulverbeschichtet in weißer Farbe

Das Set enthält: Faltbares Zeltgestell, Montagezubehör, eine Transporttasche auf Rädern.

- stelaże namiotowe wykonane z dwóch rodzajów materiałów: stali lub aluminium
 - dostępnych kilka rozmiarów
 - Everest - lżejsza konstrukcja, idealna do częstej zmiany lokalizacji
 - Blanc - ciężka, trwała konstrukcja, malowana na kolor biały
 - profil sześciokątny - trwalszy od prostokątnych
- Zestaw zawiera: stelaż namiotu, akcesoria, walizkę na kółkach.

		
BLANC (steel) 2,5x2,5	5907451661697	23 kg
BLANC (steel) 3x3	5907451661703	25 kg
BLANC (steel) 3x4,5	5907451661710	32 kg
BLANC (steel) 3x6	5907451661727	44 kg
EVEREST (aluminium) 3x3	5907451661734	17 kg
EVEREST (aluminium) 3x4,5	5907451661741	21 kg
EVEREST (aluminium) 3x6	5907451661758	32 kg

Print assembly modules:





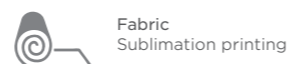





Recommended media and printing technology for this system:



TENT CANOPY

DACH FÜR ZELTE

TOIT POUR CADRE DE TENTE

-  waterproof
-  durable colours (resistant to UV radiation)
-  resistant to tearing (polyester 250-270 g)
-  wasserdicht
-  dauerhafte (UV-beständige Farben)
-  Reissfest (aus Polyester 250-270 g)
-  wodoodporny
-  trwałe kolory (odporne na promieniowanie UV)
-  odporny na rozdieranie (poliester 250-270 g)



		
3x3 white	5907451666272	3,9 kg
3x3 blue	5907451666289	3,9 kg
3x3 black	5907451666302	3,9 kg
3x3 red	5907451666296	3,9 kg
3x4,5 white	5907451666760	5 kg
3x4,5 blue	5907451666746	5 kg
3x4,5 black	5907451666777	5 kg
3x4,5 red	5907451666753	5 kg
3x6 white	5907451666715	8 kg
3x6 blue	5907451666739	8 kg
3x6 black	5907451666708	8 kg
3x6 red	5907451666722	8 kg

ACCESSORIES

HORSESHOE (of cast iron)



	
5907451661963	5 kg

WATER TANK FOR TENT LEGS (of plastic)



	
5907451669990	1 kg + 14 l

SANDBAG SINGLE



	
5907451663332	0,1 kg + 12 kg

SANDBAG DOUBLE



	
5907451661987	0,3 kg + 18 kg

FLAG BASE



	
5907451661956	1 kg

HALFBAR (of aluminium)



		
3 m	5907451661994	1,2 kg
4,5 m	5907451662007	1,6 kg



EVENT ADV FURNITURE

TABLES

- solid construction (polyethylene + steel)
- perfect for outdoor event
- non-slips pads on legs
- foldable
- special handle ensures easy transport (122, 180x75)

- solide Konstruktion (Polyethylen + Stahl)
- perfekt für Veranstaltungen im Freien
- rutschfeste Polster an den Beinen
- faltbar
- spezieller Griff für einfachen Transport (122, 180x75)

- solidna konstrukcja (polietylen + stal)
- idealne na eventy plenerowe
- antypoślizgowe nakładki na nóżki
- składane
- specjalna rączka ułatwia przenoszenie (122, 180x75)

COCKTAIL TABLE 80



5907451664957 | 8 kg

EVENT TABLE 180x75



5907451664988 | 12 kg



EVENT TABLE ROUND 122



5907451664964 | 11 kg

TABLE HEADER

- simple assembly
- great, original advertising area
- header mounted to rectangular tables
- einfache Montage
- tolle, originale Werbefläche
- titel für rechteckige Tische
- prosty montaż
- dodatkowa powierzchnia reklamowa
- header montowany do prostokątnych stołów



5907451664971 | 1,5 kg

TABLECLOTH

- flexible tablecloth
- made of polyester and elastine
- washable, no need to be ironed
- Dehnbar
- aus Polyestermaterial mit hohem Elasthan-Anteil
- waschbar, kein Bügeln erforderlich
- elastyczne
- wykonane z polietylenu z wysoką zawartością elastanu
- nadają się do prania, nie wymagają prasowania

TABLECLOTH 80



white 5907451664926 | 0,5 kg
black 5907451665220 | 0,5 kg

TABLECLOTH 122



white 5907451664933 | 0,5 kg
black 5907451665213 | 0,5 kg

TABLECLOTH 180



white 5907451664940 | 0,5 kg
black 5907451665206 | 0,5 kg

WE MEET
EXPECTATIONS

PRO
-MEDIA-
PLUS

Szubinska 32, 60-114 Poznan, Poland

+48 61 307 60 62

www.promediaplus.pl

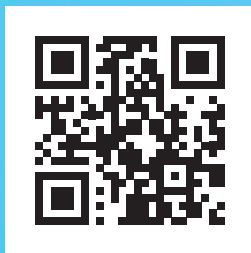

This catalog with your company's logo.

*Download from www.promediaplus.pl, put your logo
and data on, print out and use as a great sales tool.*